

# **HONDA**

## **OWNER'S MANUAL**

[Back to Main Index](#)

**95**  
**VFR750F**



## **IMPORTANT INFORMATION**

- **OPERATOR AND PASSENGER**

This motorcycle is designed to carry the operator and one passenger. Never exceed the maximum weight capacity as shown on the tire information label.

- **ON-ROAD USE**

This motorcycle is not equipped with a spark arrester and is designed to be used only on the road. Operation in forest, brush or grass covered areas may be illegal. Obey local laws and regulations.

- **READ THIS OWNER'S MANUAL CAREFULLY**

Pay special attention to the safety messages that appear throughout the manual. These messages are fully explained in the "Safety Messages" section which appears opposite the Contents page.

This manual should be considered a permanent part of the motorcycle and should remain with the motorcycle when resold.

**HONDA VFR750F  
OWNER'S MANUAL**

1995

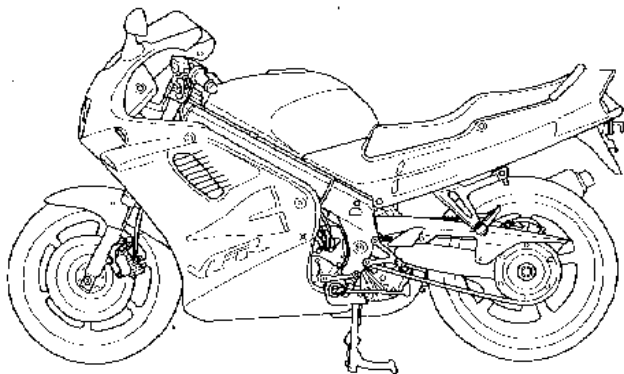

All information in this publication is based on the latest production information available at the time of approval for printing. HONDA MOTOR CO., LTD. reserves the right to make changes at any time without notice and without incurring any obligation.

No part of this publication may be reproduced without written permission.

*Honda Motor Co., Ltd. 1994*



## WELCOME

Your new motorcycle presents you with an invitation to adventure and a challenge to master the machine. Your safety depends not only on your own alertness and familiarity with the motorcycle, but also the motorcycle's mechanical condition. A pre-ride inspection before every outing and regular maintenance are essential.

To help meet the challenges safely and enjoy the adventure fully, become thoroughly familiar with this Owner's Manual **BEFORE YOU RIDE THE MOTORCYCLE**.

Also for your own and your Honda's sake, please read all the written material which came with your new Honda. These items include (USA only):

- Honda Owner's Identification Card
- Set-up and Pre-delivery Checklist
- Honda Motorcycle Warranties Booklet
- You And Your Motorcycle **RIDING TIPS & PRACTICE GUIDE**

When service is required, remember that your Honda dealer knows what it takes to keep your Honda going strong. If you have the required mechanical "know-how" and tools, your dealer can supply you with Honda's Common Service Manual and an official Model Specific Service Manual to help you perform many maintenance and repair tasks.

Pleasant riding, and thank you for choosing a Honda!

## SAFETY MESSAGES

Your safety, and the safety of others, is very important. We have provided important safety messages in this manual and on your motorcycle. Please read these messages carefully.

A safety message alerts you to potential hazards that can hurt you and others. Each safety message is preceded by a safety alert symbol and one of three words **DANGER**, **WARNING**, or **CAUTION**.

These mean:

***DANGER***

**You WILL be KILLED or SERIOUSLY HURT if you don't follow instructions.**

***WARNING***

**You CAN be KILLED or SERIOUSLY HURT if you don't follow instructions.**

***CAUTION***

**You CAN be HURT if you don't follow instructions.**

Each message tells you what the hazard is, what can happen, and what you can do to avoid or reduce injury.

### Damage Prevention Messages

You will also see other important messages that are preceded by the word **NOTICE**.

This word means:

#### **NOTICE**

Your motorcycle or other property can be damaged if you don't follow instructions.

The purpose of these messages is to help prevent damage to your Honda, other property, or the environment.

## OPERATION

Page		Page	
1	MOTORCYCLE SAFETY	42	Left Handlebar Controls
1	Important Safety Information	43	FEATURES (Not required for operation)
3	Protective Apparel	43	Steering Lock
5	Loading, Accessories and Modifications	44	Helmet Holder
9	Safety Labels	45	Seat
11	PARTS LOCATION	46	Owner's Manual Storage
14	Instruments and Indicators	47	Storage Compartment for U-shaped Lock
20	MAJOR COMPONENTS (Information you need to operate this motorcycle)	48	Rear Seat Cover
20	Suspension	50	Middle Fairing
23	Brakes	51	Side Cover
26	Clutch	52	OPERATION
28	Coolant	52	Pre-ride Inspection
30	Fuel	54	Starting the Engine
33	Engine Oil	58	Break-in
34	Tires	59	Shifting
40	ESSENTIAL INDIVIDUAL COMPONENTS	61	Braking
40	Ignition Switch	62	High Altitude Riding (USA only)
41	Right Handlebar Controls	63	Parking
		64	Anti-theft Tips

# MAINTENANCE

Page		Page	
65	MAINTENANCE	91	FRAME /WHEELS /BRAKES
65	The Importance of Maintenance	91	Brake Pad Wear
66	Maintenance Safety	93	Side Stand
67	Safety Precautions	94	Wheel Removal
68	Emission Requirements (USA only)		
69	Maintenance Schedule	101	ELECTRICAL
72	Maintenance Record	101	Battery
73	Tool Kit	104	Fuses
74	Serial Numbers		
75	Color Label	107	CLEANING
76	FILTERS/LUBRICATION	109	STORAGE GUIDE
76	Engine Oil		
80	ENGINE	112	SPECIFICATIONS
80	Spark Plugs		
83	Throttle Operation	116	CONSUMER INFORMATION
84	Idle Speed	116	Service Manuals
85	Coolant	117	Emission Control Systems
		120	Warranty Service
86	DRIVE TRAIN	121	Reporting Safety Defects
86	Drive Chain		



## **MOTORCYCLE SAFETY**

### **IMPORTANT SAFETY INFORMATION**

Your motorcycle can provide many years of service and pleasure - if you take responsibility for your own safety and understand the challenges that you can meet on the road.

There is much that you can do to protect yourself when you ride. You'll find many helpful recommendations throughout this manual. Following are a few that we consider most important.

#### **Always Wear a Helmet**

It's a proven fact: Helmets significantly reduce the number and severity of head injuries so always wear a helmet and make sure your passenger does the same. We also recommend that you wear eye protection, sturdy boots, gloves and other protective gear (page 3).

#### **Take a Rider Training Course**

Because many accidents involve inexperienced or untrained riders, we urge all riders to take a certified course approved by the Motorcycle Safety Foundation (MSF).

New riders should start with the basic course, and even experienced riders will find the advanced course beneficial. For information about the MSF training course nearest you, call the national toll-free number (800) 447-4700 (USA only).

#### **Ride Defensively**

The most frequent motorcycle collision happens when a car turns left in front of a motorcycle. Another common situation is a car moving suddenly into your lane. Always pay attention to other vehicles around you, and do not assume that other drivers see you.

Be prepared to stop quickly or make an evasive maneuver. For other riding tips, see the booklet *You and Your Motorcycle: Riding Tips and Practice Guide*, which came with your new motorcycle (USA only).

**Make Yourself Easy to See**

Some drivers do not see motorcycles because they are not looking for them. To make yourself more visible, wear bright reflective clothing, position yourself so other drivers can see you, signal before turning or changing lanes, and use your horn when it will help others notice you.

**Ride Within Your Limits**

Pushing the limits is another major cause of motorcycle accidents. Never ride beyond your personal abilities or faster than conditions warrant. Remember that alcohol, drugs, fatigue and inattention can significantly reduce your ability to make good judgments and ride safely.

**Keep Your Bike in Safe Condition**

For safe riding, it's important to inspect your motorcycle before every ride and perform all recommended maintenance. Never exceed load limits, and only use accessories that have been approved by Honda for this motorcycle. See page 5 for more details.

## **PROTECTIVE APPAREL**

For your safety, we strongly recommend that you always wear an approved motorcycle helmet, eye protection, boots, gloves, long pants, and a long-sleeved shirt or jacket whenever you ride. Although complete protection is not possible, wearing proper gear can reduce the chance of injury when you ride. Following are suggestions to help you choose proper gear.

### **WARNING**

Not wearing a helmet increases the chance of serious injury or death in a crash.

Be sure you and your passenger always wear a helmet, eye protection and other protective apparel when you ride.

## **Helmets and Eye Protection**

Your helmet is your most important piece of riding gear because it offers the best protection against head injuries. A helmet should fit your head comfortably and securely. A bright-colored helmet can make you more noticeable in traffic, as can reflective strips.

An open-face helmet offers some protection, but a full-face helmet offers more. Regardless of the style, look for a DOT (Department of Transportation) sticker in any helmet you buy (USA only), and always wear a face shield or goggles to protect your eyes and help your vision.

**Additional Riding Gear**

In addition to a helmet and eye protection, we also recommend:

- Sturdy boots with non-slip soles to help protect your feet and ankles.
- Leather gloves to keep your hands warm and help prevent blisters, cuts, burns and bruises.
- A motorcycle riding suit or jacket for comfort as well as protection. Bright-colored and reflective clothing can help make you more noticeable in traffic. Be sure to avoid loose clothes that could get caught on any part of your motorcycle.

## **LOADING, ACCESSORIES AND MODIFICATIONS**

Your motorcycle has been designed to carry you and one passenger. When you carry a passenger, you may feel some difference during acceleration and braking. But so long as you keep your motorcycle well-maintained with good tires and brakes, you can safely carry loads within the given limits and guidelines.

However, exceeding the weight limit or carrying an unbalanced load can seriously affect your motorcycle's handling, braking and stability. Non Honda accessories, improper modifications, and poor maintenance can also reduce your safety margin,

The following pages give more specific information on loading, accessories and modifications.

### **Loading**

How much weight you put on your motorcycle, and how you load it, are important to your safety. Anytime you ride with a passenger or cargo you should be aware of the following information.

#### **WARNING**

Overloading or improper loading can cause a crash and you can be seriously hurt or killed.

Follow all load limits and other loading guidelines in this manual.

## Load Limits

Following are the load limits for your motorcycle:

### Maximum weight capacity:

175 kg (386 lbs)

Includes the weight of the rider, passenger, all cargo and all accessories

### Maximum cargo weight:

27 kg (60 lbs)

## Loading Guidelines

Your motorcycle is primarily intended for transporting you and a passenger. You may wish to secure a jacket or other small items to the seat when you are not riding with a passenger.

If you wish to carry more cargo, check with your Honda dealer for advice, and be sure to read the information regarding accessories on page 7.

Improperly loading your motorcycle can affect its stability and handling. Even if your motorcycle is properly loaded, you should ride at reduced speeds and never exceed 80 mph (130 km/h) when carrying cargo.

Follow these guidelines whenever you carry a passenger or cargo:

- Check that both tires are properly inflated.
- If you change your normal load, you may need to adjust the front suspension (page 20) and the rear suspension (page 21).
- To prevent loose items from creating a hazard, make sure that all cargo is securely tied down before you ride away.
- Place cargo weight as close to the center of the motorcycle as possible.
- Balance cargo weight evenly on both sides.

### Accessories and Modifications

Modifying your motorcycle or using non-Honda accessories can make your motorcycle unsafe. Before you consider making any modifications or adding an accessory, be sure read the following information.

#### **WARNING**

Improper accessories or modifications can cause a crash in which you can be hurt or killed.

Follow all instructions in this owner's manual regarding accessories and

### Accessories

We strongly recommend that you use only genuine Honda accessories that have been specifically designed and tested for your motorcycle. Because Honda cannot test all other accessories, you must be personally responsible for proper selection, installation and use of non-Honda accessories. Check with your dealer for assistance and always follow these guidelines:

- Make sure the accessory does not obscure any lights, reduce ground clearance and banking angle, limit suspension travel or steering travel, alter your riding position or interfere with operating any controls.
- Be sure electrical equipment does not exceed the motorcycle's electrical system capacity (page 115). A blown fuse can cause a loss of lights or engine power.

- Do not pull a trailer or sidecar with your motorcycle. This motorcycle was not designed for these attachments, and their use can seriously impair your motorcycle's handling.

**Modifications**

We strongly advise you not to remove any original equipment or modify your motorcycle in any way that would change its design or operation. Such changes could seriously impair your motorcycle's handling, stability and braking, making it unsafe to ride.

Removing or modifying your lights, mufflers, emission control system or other equipment can also make your motorcycle illegal.



**SAFETY LABELS**

The following shows the locations of safety labels on your motorcycle. Some labels warn you of potential hazards that could cause serious injury. Others provide important safety information. Read these labels carefully and don't remove them.

If a label comes off or becomes hard to read, contact your Honda dealer for a replacement.

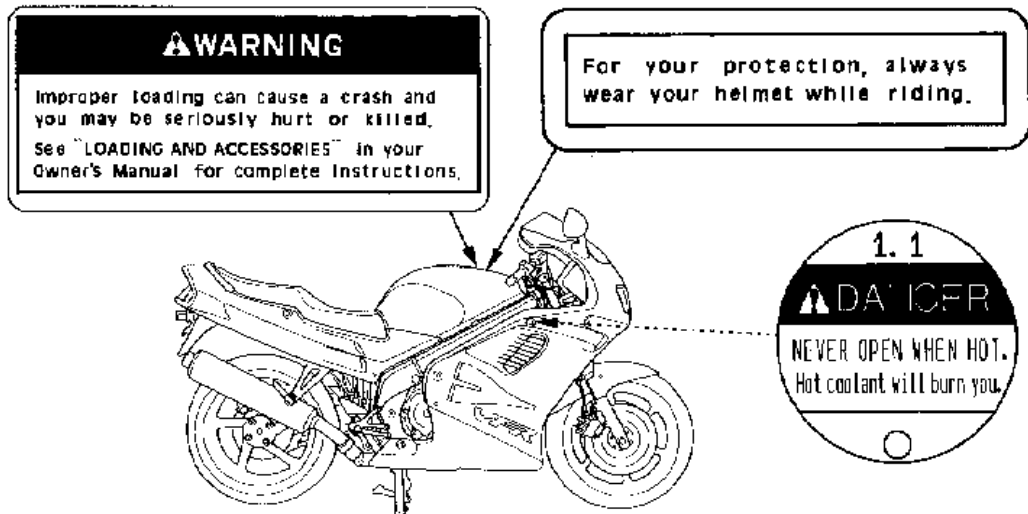

## TIRE INFORMATION

COLD TIRE PRESSURES :  
 (UP TO MAXIMUM WEIGHT CAPACITY) FRONT : 250kPa (2.50 kg/cm<sup>2</sup>, 36 psi)  
 REAR : 290kPa (2.90 kg/cm<sup>2</sup>, 42 psi)  
 (UP TO 90kg (200 lbs) LOAD) FRONT : 250kPa (2.50 kg/cm<sup>2</sup>, 36 psi)  
 REAR : 290kPa (2.90 kg/cm<sup>2</sup>, 42 psi)  
 MAXIMUM WEIGHT CAPACITY : (175 kg / 386 lbs.)  
 TIRE SIZE : FRONT (120/70 ZR17) REAR (170/60 ZR17)

THIS MOTORCYCLE IS EQUIPPED WITH TUBELESS TIRES.

TIRE BRAND	FRONT	REAR
BRIDGESTONE	B154 RADIAL G	B154R RADIAL G
DUNLOP	D202E N	D202 J
MICHELIN	A89X	M89X

M.N. RECOMMEND TIRE CENTER  
 TREAD DEPTH  
 FRONT 1.5mm (0.06 in) REAR 2.0mm (0.08 in)

Read Owner's Manual

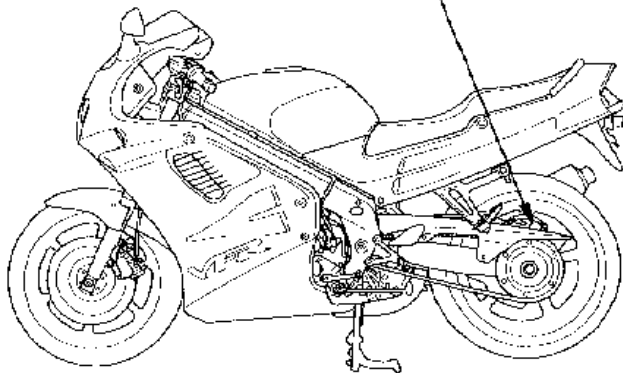

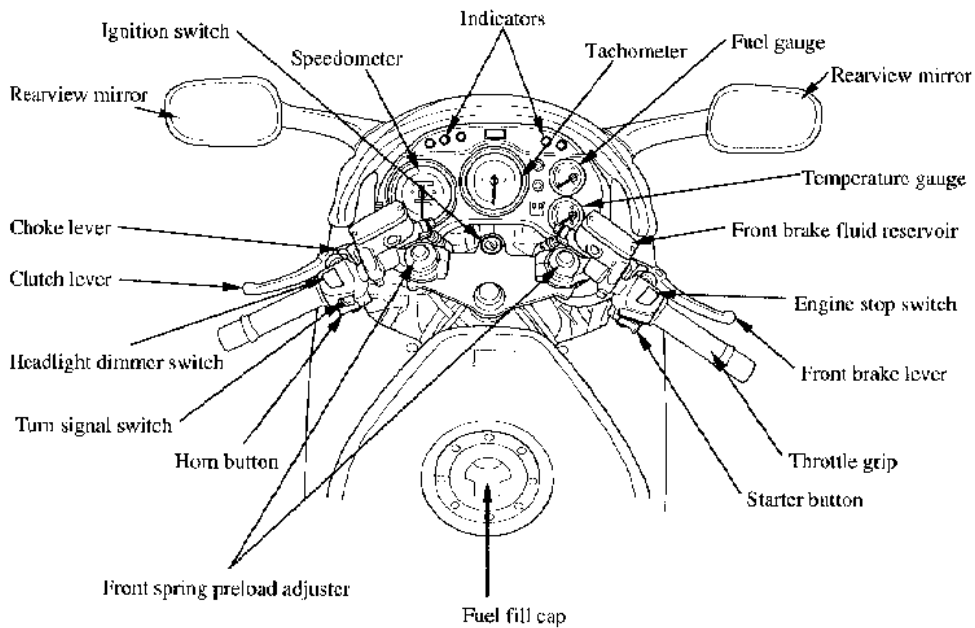
**PARTS LOCATION**

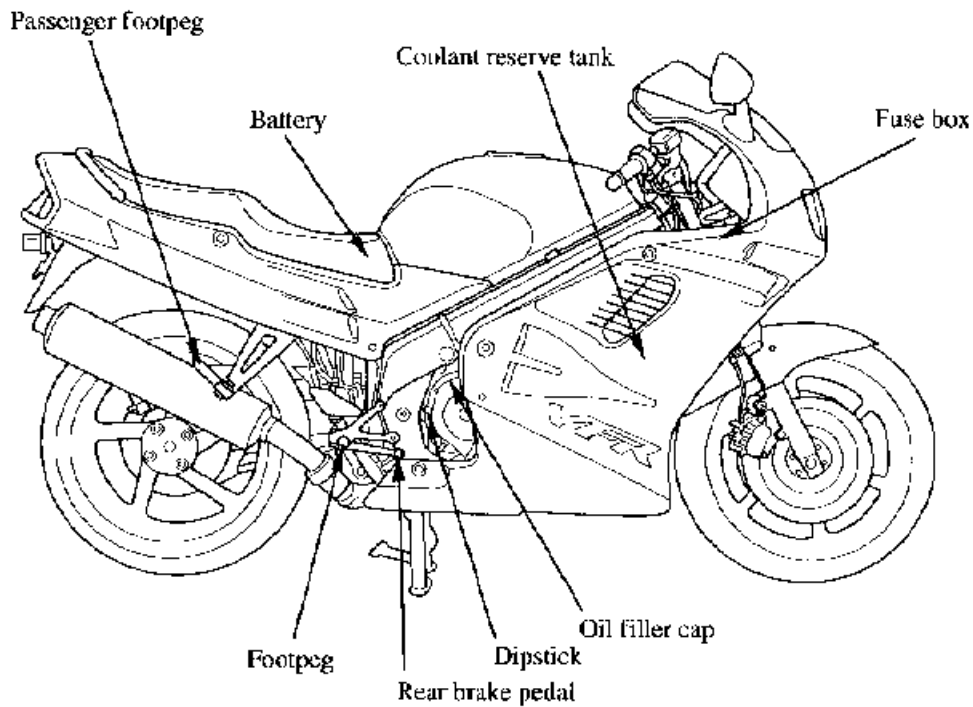

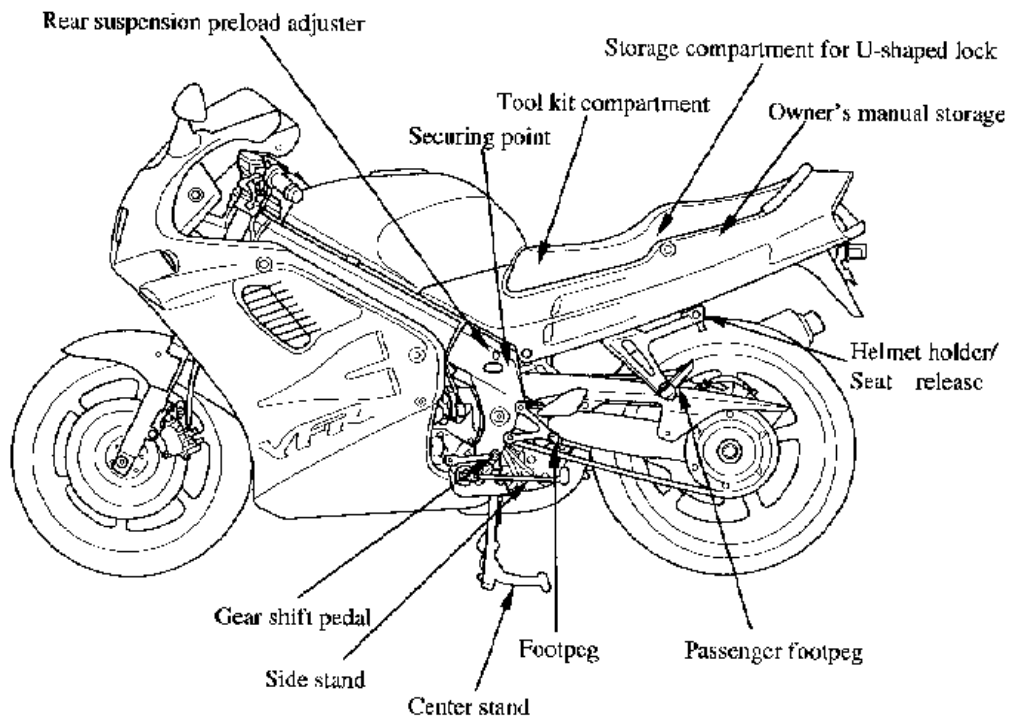

## INSTRUMENTS AND INDICATORS

The indicators are contained in the instrument panel. Their functions are described in the tables on the following pages.

### USA model:

Odometer and tripmeter read in miles.

### Canadian model:

Odometer and tripmeter read in kilometers.

- (1) Speedometer
- (2) Odometer
- (3) Left turn signal indicator
- (4) Side stand indicator
- (5) High beam indicator
- (6) Digital clock
- (7) Tachometer
- (8) Tachometer red zone
- (9) Neutral indicator
- (10) Right turn signal indicator
- (11) Fuel indicator
- (12) Fuel gauge
- (13) Coolant temperature gauge

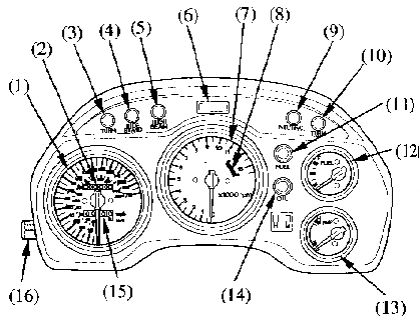

- (14) Low oil pressure indicator
- (15) Tripmeter
- (16) Tripmeter reset knob

<b>(Ref.No.) Description</b>	<b>Function</b>
(1) Speedometer	Shows riding speed.
(2) Odometer	Shows accumulated mileage.
(3) Left turn signal indicator (Amber)	Flashes when the left turn signal operates.
(4) Side stand indicator	Lights when the side stand is put down. Before parking, check that the side stand is fully down; the light only indicates the side stand ignition cut-off system (page 54) is activated.
(5) High beam indicator (Blue)	Lights when the headlight is on high beam.
(6) Digital clock	Shows the time (page 19).
(7) Tachometer	Shows engine RPM.
(8) Tachometer red zone	Shows excessive engine rpm range in which operation may damage the engine.
(9) Neutral indicator (Green)	Lights when the transmissions in neutral.
(10) Right turn signal indicator (amber)	Flashes when the right turn signal operates.

<b>(Ref.No.) Description</b>	<b>Function</b>
(11) Fuel indicator (Red)	When this indicator comes on while riding, fuel reserved in the tank is about: 3.3 L (0.87 US gal, 0.73 Imp gal) Should also light for a few seconds and then go off when the ignition switch is turned ON. If it comes on any other time, refill the fuel tank as soon as possible (page 30).
(12) Fuel gauge	Shows approximate fuel supply available (page 18).
(13) Coolant temperature gauge	Shows coolant temperature(page 17).
(14) Low oil pressure indicator (Red)	Lights when the engine oil pressure is below the normal operating range. Should light when ignition switch is ON and engine is not running. Should go out when the engine starts, except for occasional flickering at or near idling speed when engine is warm.
(15) Tripmeter	Shows mileage per trip.
(16) Tripmeter reset knob	Resets tripmeter to zero (0) by turning the knob in direction shown.



### Coolant Temperature Gauge

When the needle begins to move above the C (Cold) mark, the engine is warm enough for the motorcycle to be ridden. The normal operating temperature range is within the section between the H and C marks. If the needle reaches the H (Hot) mark, stop the engine and check the reserve tank coolant level. Read pages 28 - 29 and do not ride the motorcycle until the problem has been corrected.

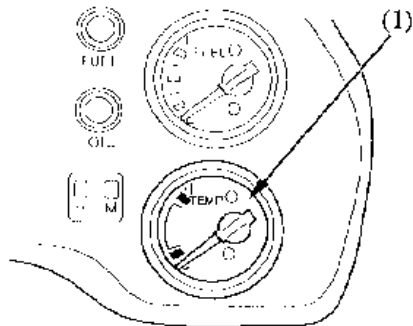

### NOTICE

Exceeding maximum running temperature can cause serious engine damage

**Fuel Gauge**

The fuel gauge (1) shows the approximate fuel supply available. At F (Full), the fuel tank capacity including reserve is:

*21.0 L (5.55 US gal ,4.62 Imp gal)*

When the gauge needle first points to E, refill the tank as soon as possible. At E there is:

*2.8 L (0.74 US gal,0.62 Imp gal)*

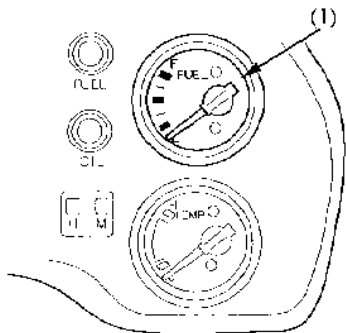

(1) Fuel gauge

**Digital clock**

The digital clock displays the time.

To adjust time, proceed as follows:

turn the ignition switch to the ON position.

Hour..... Press the Hour button(1) until  
the correct hour is displayed.

Minute..... Press the Min. button (2) until  
the correct minute is displayed.  
The clock is now set.

The clock will display 1:00 if the battery is  
reconnected.

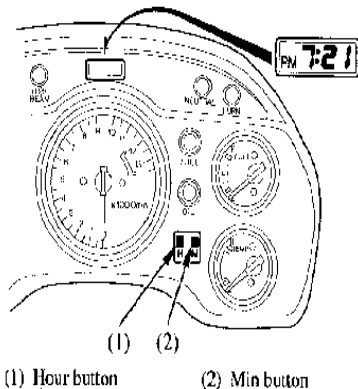

## MAJOR COMPONENTS

### Information you need to operate this Motorcycle

## SUSPENSION

### Front Suspension

#### Spring preload adjuster:

adjust the spring preload by turning the preload adjuster(1) with the No. 2 screwdriver provided in the tool kit.

To reduce (SOFT):

Turn the adjuster counterclockwise toward SOFT for a light load and smooth road condition.

To increase (HARD):

Turn the adjuster clockwise toward HARD for a firmer ride and rough road condition.

Standard position

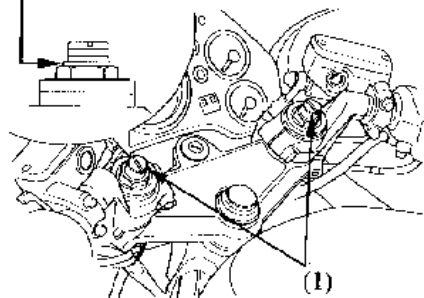

(1) Preload adjuster

## Rear Suspension

### Rebound damping adjuster.

To adjust the adjuster to the standard position, proceed as follows:

1. Turn the damping adjuster (1) clockwise until it will no longer turn. This is the full hard setting.
2. Turn the adjuster counterclockwise approximately 1 turn so that its punch mark (2) aligns with the reference punch mark (3).  
Then the adjuster is set in the standard position.

To reduce (SOFT):

Turn the adjuster counterclockwise toward SOFT for a light load and smooth road conditions.

To increase (HARD):

Turn the adjuster clockwise toward HARD for a firmer ride and rough road conditions.

The rear shock absorber assembly includes a damper unit that contains high pressure nitrogen gas. Do not attempt to disassemble or service the damper; it cannot be rebuilt and must be replaced when worn out. Disposal should only be done by your authorized Honda dealer. The instructions found in this owner's manual are limited to adjustment of the shock assembly only.

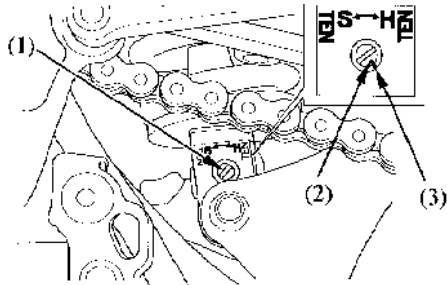

- (1) Rebound damping adjuster
- (2) Punch mark
- (3) Reference punch mark

Spring preload adjuster:

The spring preload adjuster (1) has 36 positions for different load or riding conditions. Use the 8 mm box wrench (2) and pin spanner (3) as shown to adjust the rear shock.

The standard position: STD (red dot).

To reduce (SOFT):

Turn the adjuster counterclockwise toward LOW for a light load and smooth road condition.

To increase (HARD):

Turn the adjuster clockwise toward HIGH for a finer ride and rough road condition.

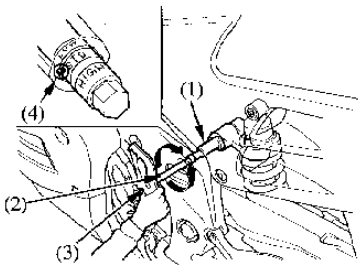

- |                     |                        |
|---------------------|------------------------|
| (1) Spring adjuster | (3) Pin spanner        |
| (2) 8 mm box wrench | (4) STD mark (red dot) |

## BRAKES

Both front and rear brakes are hydraulic disc types.

As the brake pads wear, the brake fluid level will drop. A leak in the system will also cause the level to drop. Therefore, the brake fluid level and pad wear must be inspected periodically. The system must be inspected frequently to ensure there are no fluid leaks. If the control lever or pedal free travel becomes excessive and the brake pads are not worn beyond the recommended limit (page 91) there is probably air in the brake system and it must be bled. See your authorized Honda dealer for this service.

### Front Brake Fluid Level:

With the motorcycle in an upright position, check the fluid level. It should be above the LOWER level mark (1). If the level is at or below the LOWER level mark(1), check the brake pads for wear(page 91).

Worn pads should be replaced. If the pads are not worn, have your brake system inspected for leaks.

The recommended brake fluid is Honda DOT 4 brake fluid from a sealed container, or an equivalent.

### Front

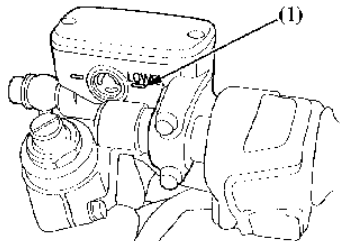

(1) LOWER level mark

**Rear Brake Fluid Level:**

With the motorcycle in an upright position, check the fluid level. It should be between the UPPER (1) and LOWER (2) level marks. If the level is at or below the LOWER level mark (2), check the brake pads for wear (page 92).

Worn pads should be replaced. If the pads are not worn, have your brake system inspected for leaks.

The recommended brake fluid is Honda DOT 4 brake fluid from a sealed container, or an equivalent.

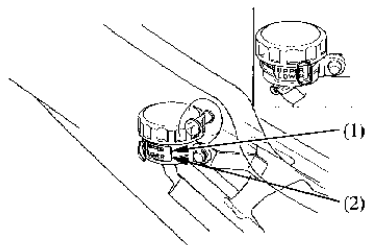
**Rear**

- (1) UPPER level mark
- (2) LOWER level mark



**Front Brake Lever:**

The distance between the tip of the brake lever (1) and the grip can be adjusted by turning the adjuster (2).

Align the arrow (3) on the brake lever with the index mark (4) on the adjuster.

Apply the brake several times and check for free wheel rotation after the brake lever is released.

**Other checks:**

Make sure there are no fluid leaks. Check for deterioration or cracks in the hoses and fittings.

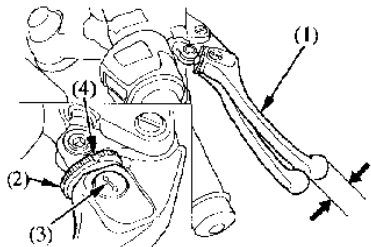

(1) Brake lever  
(2) Adjuster

(3) Arrow  
(4) Index mark

## CLUTCH

This motorcycle has a hydraulically actuated clutch. There are no adjustments to perform but the clutch system must be inspected periodically for fluid level and leakage. If the control lever freeplay becomes excessive and the motorcycle creeps or stalls when shifted into gear, or if the clutch slips, causing acceleration to lag behind engine speed, there is probably air in the clutch system and it must be bled out. See your authorized Honda dealer for this service.

### Fluid Level:

Check that the fluid level is above the LOWER level mark (1). If the fluid level is near the LOWER level mark, it indicates fluid leakage. See your authorized Honda dealer.

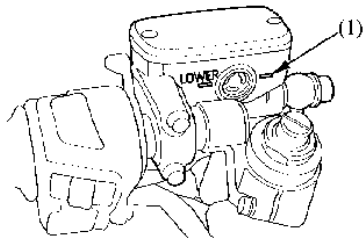

(1) LOWER level mark

**Clutch lever:**

The distance between the tip of the clutch lever (1) and the grip can be adjusted by turning the adjuster (2).

Align the arrow (3) on the clutch lever with the index mark (4) on the adjuster.

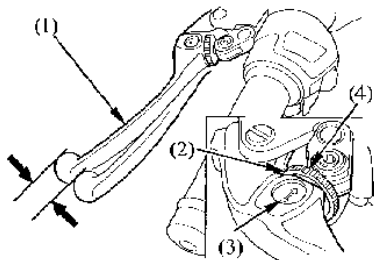

(1) Clutch lever  
(2) Adjuster

(3) Arrow  
(4) Index mark

**Other checks:**

Make sure there are no fluid leaks. Check for deterioration or cracks in the hoses and fittings.

**COOLANT****Coolant Recommendation**

The owner must properly maintain the coolant to prevent freezing, overheating and corrosion. Use only high quality ethylene glycol antifreeze containing corrosion protection inhibitors specifically recommended for use in aluminum engines. (SEE ANTIFREEZE CONTAINER LABEL).

Use only low-mineral drinking water or distilled water as a part of the antifreeze solution. Water that is high in mineral content or salt may be harmful to the aluminum engine.

The factory provides a 50/50 solution of antifreeze and distilled water in this motorcycle. This coolant solution is recommended for most operating temperatures and provides good corrosion protection. A higher concentration of antifreeze decreases the cooling system performance and is recommended only when additional protection against freezing is needed. A concentration of less than 40/60 (40% antifreeze) will not Provide proper corrosion protection.

During freezing temperatures, check the cooling system frequently and add higher concentrations of antifreeze (up to a maximum of 60% antifreeze) if required.

### Inspection

The reserve tank is behind the right middle fairing.

Check the coolant level in the reserve tank while the engine is at normal operating temperature. It should be between the UPPER (1) and LOWER (2) level marks. If the coolant level begins to reach the LOWER level mark (2), add coolant to the UPPER level mark (1). If the reserve tank is empty, or if coolant loss is excessive, check for leaks and see your authorized Honda dealer for repair.

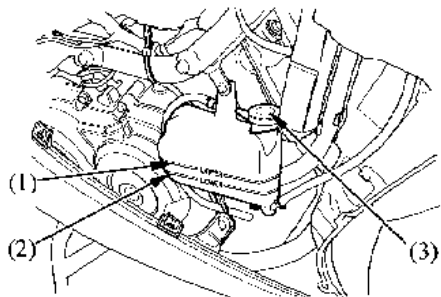
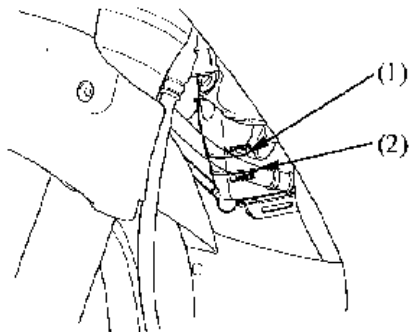

- (1) UPPER level mark
- (2) LOWER level mark
- (3) Reserve tank cap

## Fuel Tank

The fuel tank capacity, including reserve, is:  
21.0 L (5.55 US gal , 4.62 Imp gal)

To open the fuel fill cap(1), insert the ignition key (2) and turn it clockwise. The cap will pop up and can be lifted off.

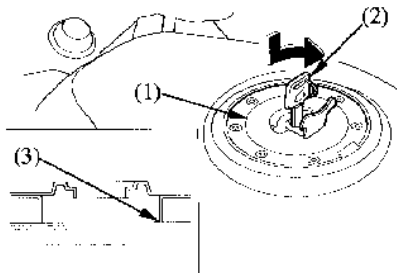

(1) Fuel fill cap

(2) Ignition key

(3) Filler neck

Do not overfill the tank. There should be no fuel in the filler neck (3).

After refueling, to close the fuel fill cap, align the latch in the cap with the slot in the filler neck. Push the cap into the filler neck until it snaps closed and locks. Remove the key.

## WARNING

Gasoline is highly flammable and explosive and you can be burned or seriously injured when refueling.

- Stop engine and keep heat, sparks, and flame away.
- Refuel only outdoors.
- Wipe up spills immediately.

Your engine is designed to use any gasoline that has a pump octane number of 86 or higher. Gasoline pumps at service stations normally display the pump octane number.

We recommend that you use unleaded fuel because it produces fewer engine and spark plug deposits and extends the life of exhaust system components.

Never use stale or contaminated gasoline or an oil/gasoline mixture. Avoid getting dirt, dust or water in the fuel tank. Use of a lower octane gasoline can cause persistent "pinging" or heavy "spark knock" (a metallic rapping noise) which, if severe, can lead to engine damage.

**NOTICE**

If "spark knock" or "pinging" occurs at a steady engine speed under normal load, change brands of gasoline. If spark knock or pinging persists, consult your authorized Honda dealer. Failure to do so is considered misuse, and damage caused by misuse is not covered by Honda's Limited Warranty.

Occasionally you may experience light spark knock while operating under heavy loads. This is no cause for concern, it simply means your engine is operating efficiently.

## Oxygenated Fuels

Some conventional gasoline's are being blended with alcohol or an ether compound. These gasoline's are collectively referred to as oxygenated fuels. To meet clean IR standards, some areas of the United States and Canada use oxygenated fuels to help reduce emissions.

If you use an oxygenated fuel, be sure it is unleaded and meets the minimum octane rating requirement.

Before using an oxygenated fuel, try to confirm the fuel's contents. Some states/provinces require this information to be posted on the pump. The following are the EPA (The U.S. Environmental Protection Agency) approved percentages of oxygenates:

**ETHANOL** (ethyl or grain alcohol) 10% by Volume

You may use gasoline containing up to 10% ethanol by volume. Gasoline containing ethanol may be marketed under the name "Gasohol"

**MTBE** (Methyl Tertiary Butyl Ether) 15% by Volume  
You may use gasoline containing up to 15% MTBE by volume.

**METHANOL** (methyl or wood alcohol) 5% by Volume

You may use gasoline containing up to 5% methanol by volume as long as it also contains cosolvents and corrosion inhibitors to protect the fuel system.

Gasoline containing more than 5% methanol by volume may cause starting and/or performance problems. It may also damage metal, rubber, and plastic parts of your fuel system.

If you notice any undesirable operating symptoms, try another service station or switch to another brand of gasoline.

Fuel system damage or performance problems resulting from the use of an oxygenated fuel containing more than the percentages of oxygenates mentioned above are not covered under warranty.



## ENGINE OIL

### Engine Oil Level Check

Check the engine oil level each day before operating the motorcycle.

#### NOTICE

Running the engine with insufficient oil pressure may cause serious engine damage.

#### To check the oil level:

1. Place the motorcycle on its center stand on firm, level ground.
2. Start the engine and let it idle for a few minutes. Make sure the low oil pressure indicator goes off. If the indicator remains on, stop the engine immediately.
3. Stop the engine.
4. After a few minutes, remove the dipstick(1), wipe it clean, and reinsert the dipstick without screwing it in. Remove the dipstick. The oil level should be between the upper (2) and lower (3) marks on the dipstick.

5. If required, remove the oil filler cap (4) and add the specified oil (page 76) up to the upper level mark. Do not overfill.
6. Reinstall the dipstick and oil filler cap. Check for oil leaks.

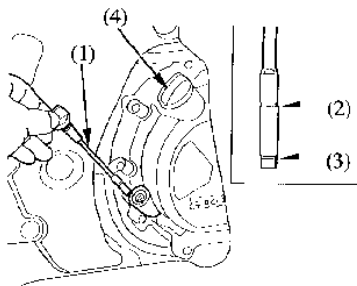

- |                      |                      |
|----------------------|----------------------|
| (1) Dipstick         | (3) Lower level mark |
| (2) Upper level mark | (4) Oil filler cap   |

## **TIRES**

To safely operate your motorcycle, your tires must be the proper type and size, in good condition with adequate tread, and correctly inflated for the load you are carrying. The following pages give more detailed information on how and when to check your air pressure, how to inspect your tires for damage, and what to do when your tires need to be repaired or replaced.

### **WARNING**

Using tires that are excessively worn or improperly inflated can cause a crash in which you can be seriously hurt or killed.

Follow all instructions in this owner's manual regarding tire inflation and maintenance.

## **Air Pressure**

Keeping your tires properly inflated provides the best combination of handling, tread life and riding comfort. Under inflated tires wear unevenly, adversely affect handling, and are more likely to fail from being overheated. Over inflated tires make your motorcycle ride more harshly, are more prone to damage from road hazards, and wear unevenly.

We recommend that you visually check your tires before every ride and use a gauge to measure air pressure at least once a month or any time you think the tires might be low. Tubeless tires have some self-sealing ability if they are punctured. However, because leakage is often very slow, you should look closely for punctures whenever a tire is not fully inflated.

Always check air pressure when your tires are "cold" -- when the motorcycle has been parked for at least three hours. If you check air pressure when your tires are "warm" -- when the motorcycle has been ridden for even a few miles -- the readings will be higher than if the tires were "cold". This is normal, so do not let air out of the tires to match the recommended cold air pressures given below. If you do, the tires will be under inflated.

The recommended "cold" tire pressures are:

Front	250 kPa(2.50 kg/cm <sup>2</sup> ,36psi)
Rear	290 kPa(2.90 kg/cm <sup>2</sup> .42psi)

### **Inspection**

Whenever you check the tire pressures, you should also examine the tire treads and sidewalls for Wear, damage, and foreign objects:

Look for:

- Bumps or bulges in the side of the tire or the tread. Replace the tire if you find any bumps or bulges.
- Cuts, splits or cracks in the tire. Replace the tire if you can see fabric or cord.
- Excessive tread wear.

Also, if you hit a pothole or hard object, pull to the side of the road as soon as you safely can and carefully inspect the tires for damage.

### Tread Wear

For the best performance, you should replace a tire before the tread depth at the center reaches 1.5 mm (0.06 in.) for the front tire, and 2.0 mm (0.08 in.) for the rear tire. If the wear indicators (1) are visible, replace the tire immediately as it is no longer safe.

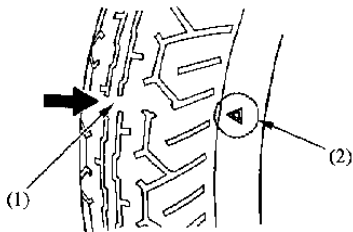

(1) Wear indicator

(2) Wear indicator location mark

**Tire Repair**

If a tire is punctured or damaged, you should replace it, not repair it. As discussed below, a tire that is repaired, either temporarily or permanently, will have lower speed and performance limits than a new tire.

A temporary repair, such as an external tubeless tire plug, may not be safe for normal speeds and riding conditions. If a temporary or emergency repair is made to a tire, you should ride slowly and cautiously to a dealer and have the tire replaced. If possible, you should not carry a passenger or cargo until a new tire is installed.

Even if a tire is professionally repaired with a permanent internal patch plug, it will not be as good as a new tire. You should not exceed 50 mph (80 km/h) for the first 24 hours, or 80 mph (130 km/h) at any time thereafter. In addition, you may not be able to safely carry as much weight as with a new tire. Therefore, we strongly recommend that you replace a damaged tire. If you choose to have a tire repaired, be sure the wheel is balanced before you ride.

**Tire Replacement**

The tires that came on your motorcycle were designed to match the performance capabilities of your motorcycle and provide the best combination of handling, braking, durability and comfort.

**WARNING**

Installing improper tires on your motorcycle can affect handling and stability. This can cause a crash in which you can be seriously hurt or killed.

Always use the size and type of tires recommended in this owner's manual.

The recommended tires for your motorcycle are:

Front:	120/70 ZR 17	
	BRIDGESTONE	BT-54F RADIAL G
	DUNLOP	D202F N
	MICHELIN	A89X

Rear:	170/60ZR17	
	BRIDGESTONE	BT-54R Radial G
	DUNLOP	D202J
	MICHELIN	M89X

Whenever you replace a tire, use one that is equivalent to the original and be sure the wheel is balanced after the new tire is installed.

**Important Safety Reminders**

- Do not install a tube inside a tubeless tire on this motorcycle. Excessive heat build-up can cause the tube to burst.
- Use only tubeless tires on this motorcycle. The rims are designed for tubeless tires, and during hard acceleration or braking, a tube type tire could slip on the rim and cause the tire to rapidly deflate.

**ESSENTIAL INDIVIDUAL COMPONENTS****IGNITION SWITCH**

The ignition switch (1) is located below the indicator panel.

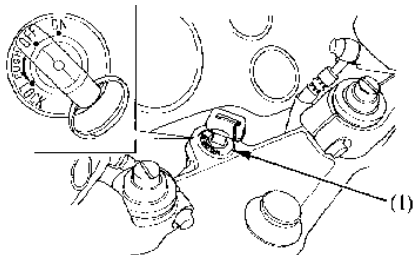

(1) Ignition switch

**Key Position****Function**

LOCK  
(steering lock)

Steering is locked. Engine and lights cannot be operated.

OFF

Engine and lights cannot be operated.

ON

Headlight, taillight and instrument lights are on and other lights can be operated. Engine can be started.

**Key Removal**

Key can be removed

Key can be removed

Key cannot be removed



## RIGHT HANDLEBAR CONTROLS

### Engine Stop Switch

The engine stop switch (1) is next to the throttle grip. When the switch is in the RUN position, the engine will operate. When the switch is in the OFF position, the engine will not operate. This switch is intended primarily as a safety or emergency switch and should normally remain in the RUN position.

If your motorcycle is stopped with the ignition switch ON and the engine stop switch OFF, the headlight and taillight will still be on, resulting in battery discharge.

### Starter Button

The starter button (2) is below the engine stop switch (1).

When the starter button is pressed, the starter motor will crank the engine; the headlight will automatically go out, but the taillight will stay on.

The starter motor will not operate when the starter button is pressed if the engine stop switch is in the OFF position.

See pages 55 - 56 for "Starting Procedure."

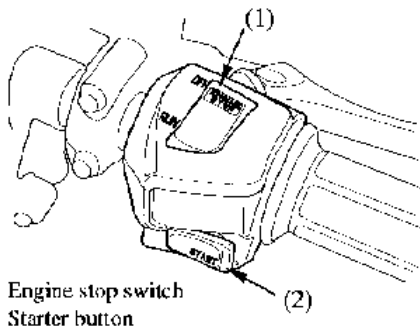

## LEFT HANDLEBAR CONTROLS

The three controls next to the left handlebar grip are:

### Headlight Dimmer Switch (1)

Select HI for high beam, LO for low beam.

### Turn Signal Switch (2)

Move to L to signal a left turn, R to signal a right turn. Press to turn signal off.

### Horn Button (3)

Press the button to sound the horn.

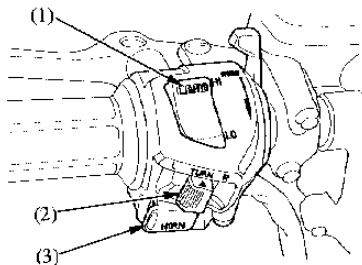

(1) Headlight dimmer switch

(2) Turn signal switch

(3) Horn button

**FEATURES (Not required for operation)**  
**STEERING LOCK**

To lock the steering, turn the handlebars all the way to the left or right, turn the key (1) to LOCK while pushing in. Remove the key.

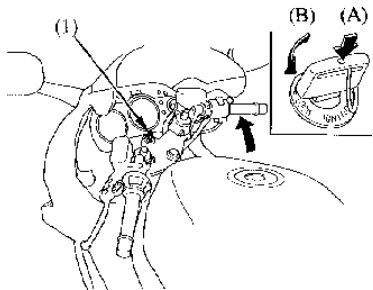

(1) Ignition key

(A) Push in

(B) Turn to LOCK

**HELMET HOLDER**

The helmet holder(1) is on the left side below the seat. The helmet holder is designed to secure your helmet while parked.

Insert the ignition key (2)and turn it clockwise to unlock.

Hang your helmet on the holder (3). Turn the key counterclockwise to lock the holder and then remove the key.

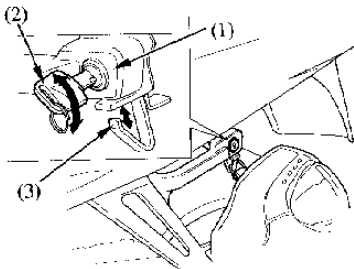

(1) Helmet holder

(2) Ignition key

(3) Holder

**WARNING**

Riding with a helmet attached to the holder can interfere with the rear wheel or suspension and could cause a crash in which you can be seriously hurt or killed.

If you must carry an extra helmet, use a commercially available elastic cord or strap to secure the helmet to the

**SEAT**

To remove the seat (1), insert the ignition key (2) into the helmet holder (3), turn it clockwise and pull the seat lock lever (4) downward. Pull the seat back and up.

To install the seat, insert the prong into the recess under the frame cross member and then push down on the rear of the seat. Turn the key counterclockwise to lock the seat, then remove the key.

Be sure to securely lock the seat after reinstalling it.

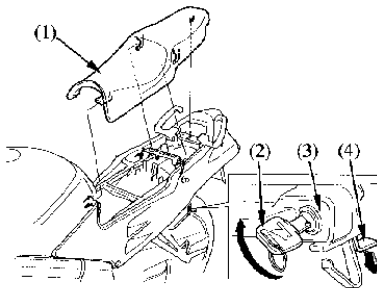

(1) Seat  
(2) Ignition key

(3) Helmet holder  
(4) Seat lock lever

**OWNER'S MANUAL STORAGE**

The owner's manual (and other documents) should be stored in the plastic bag (1) in the owner's manual storage compartment (2) under the seat.

When washing your motorcycle, be careful not to flood this area with water.

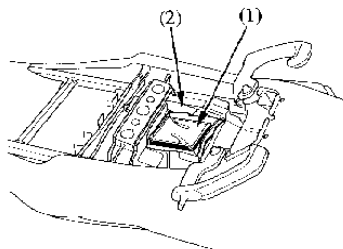

- (1) Owner's manual storage bag
- (2) Owner's manual storage compartment

### STORAGE COMPARTMENT FOR U-SHAPED LOCK

The rear fender has a storage compartment to store a U-shaped lock under the seat. After storing, be sure to fasten the lock with the rubber band ( 1 ) securely.

Some U-shaped locks may not be stored in the compartment due to their size or design.

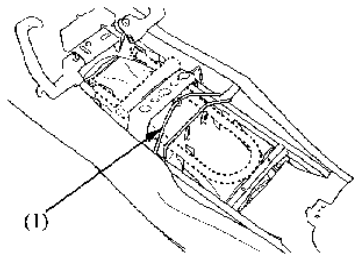

(1) Rubber band

**REAR SEAT COVER**

See your authorized Honda dealer for removal installation of the rear seat cover.

**Installation:**

1. Remove the seat (page 45).
2. Remove the mounting bolts (1) and grab rails (2).  
Install the mounting bolts(1).

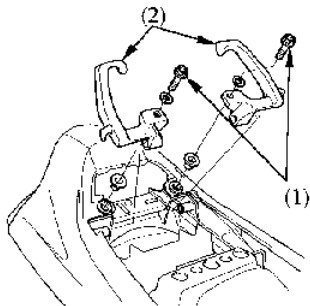

(1) Mounting bolts      (2) Rear grab rails

3. Remove the mounting bolts (3) and cowl plugs (4).  
install the seat securely, then install the rear seat cover (5). Set the right and left mounting bolts (3) and tighten them securely.

The grab rails must be installed in the upright position when riding in tandem.

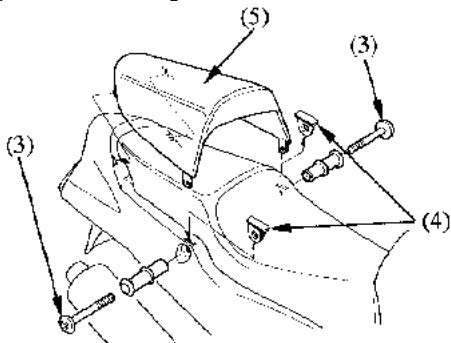

(3) Mounting bolts      (5) Rear seat cover  
(4) Cowl plugs



**Removal:**

1. Removal can be done in the reverse order of installation. Tighten the rear grab rail mounting bolts (1) securely.

TORQUE: 35 N-m(3.5 kg-m, 25 lb-ft)

If a torque wrench was not used for installation, see your authorized Honda dealer as soon as possible to verify proper assembly. The grab rail could come off easily and result in serious injury if the assembly is not made properly.

2. Install the seat properly (page 45).

## MIDDLE FAIRING

### Removal

1. Remove the bolt (2).
2. Turn the clips (3) 90° counterclockwise, remove the mounting clips (4).
3. Pull the middle fairing (1) out by releasing the tabs (5) from the upper fairing (6).

### Installation:

1. Installation can be done in the reverse order of removal.

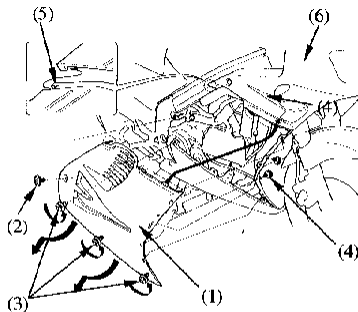

- |                    |                    |
|--------------------|--------------------|
| (1) Middle fairing | (4) Mounting clips |
| (2) Bolt           | (5) Tabs           |
| (3) Clips          | (6) Upper fairing  |

**SIDE COVER**

The side cover(1) must be removed to add the rear brake fluid.

**Removal:**

1. Remove the seat(page 45).
2. Disconnect the stoplight and rear turn signal light connector (2).
3. Remove the mounting bolts (3).
4. Pull out both side cover tabs (4).
5. Slide the cover upward.

**Installation:**

1. Installation can be done in the reverse order of removal.

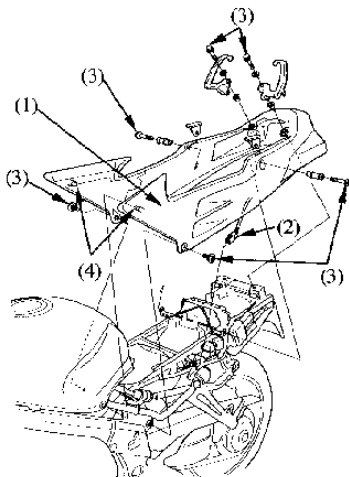

(1) Side cover

(2) Connector

(3) Bolts

(4) Tabs

## OPERATION

### PRE-RIDE INSPECTION

For your safety, it is very important to take a few moments before each ride to walk around your motorcycle and check its condition. If you detect any problem, be sure you take care of it, or have it corrected by your Honda dealer.

### WARNING

Improperly maintaining this motorcycle or failing to correct a problem before riding can cause a crash in which you can be seriously hurt or killed.

Always perform a pre-ride inspection before every ride and correct any problems.

Check the following items before you get on the motorcycle:

- **Tires** If a tire looks low, check the air pressure with a gauge. Also look for signs of damage or excessive wear (page 36).
- **Leaks** Look for signs of leaking fluids under the motorcycle.
- **Chain** Check condition and adjust slack and lubricate as needed (page 89).
- **Cables** Check for loose cables and other parts, and anything that appears abnormal.

Check these items after you get on the motorcycle:

- **Throttle** Rotate the throttle to check that it moves smoothly without binding.
- **Brakes** Pull the brake lever and press on the brake pedal to check that they operate normally.

- **Gauges** Turn the ignition on and check for normal operation of the gauges and indicators.
- **Lights** Make sure the brake light, taillight and other lights are working properly.

Remember, be sure to take care of any Problem you find, or have your dealer correct it, before you ride.

## STARTING THE ENGINE

This motorcycle is equipped with a side stand ignition cut-off system. The engine cannot be started if the side stand is down, unless the transmission is in neutral. If the side stand is up, the engine can be started in neutral or in gear with the clutch lever pulled in. After starting with the side stand down, the engine will stop if the transmission is put in gear before raising the side stand.

Your motorcycle's exhaust contains poisonous carbon monoxide gas. High levels of carbon monoxide can collect rapidly in enclosed areas such as a garage. Do not run the engine with the garage door closed. Even with the door open, run the engine only long enough to move your motorcycle out of the garage.

Do not use the electric starter for more than 5 seconds at a time. Release the starter button for approximately 10 seconds before pressing it again.

## Preparation

Before starting, insert the key, turn the ignition switch ON and confirm the following:

- The transmission is in NEUTRAL
- (neutral indicator light ON).
- The engine stop switch is at RUN.
- The low oil pressure indicator is ON.
- The fuel valve is ON.

The low oil pressure indicator should go off a few seconds after the engine starts. If the light stays on, stop the engine immediately and check the engine oil level.

### NOTICE

Operating the engine with insufficient oil pressure can cause serious engine damage.

## Starting Procedure

To restart a warm engine, follow the procedure for "High Air Temperature".

### Normal Air Temperature

10° - 35° C (50° - 95° F)

1. Pull the choke lever(1) back all the way to Fully ON(A), if the engine is cold.
2. Start the engine, leaving the throttle closed.

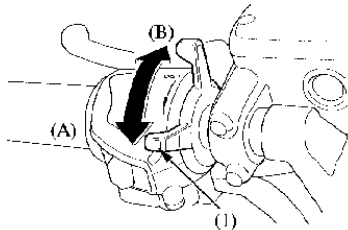

(1) Choke lever

(A) Fully ON

(B) Fully OFF

Do not open the throttle when starting the engine with the choke ON. This will lean the mixture, resulting in hard starting.

### **NOTICE**

Operating the engine with insufficient oil pressure can cause serious engine damage.

3. Immediately after the engine starts, operate the choke lever( 1) to keep fast idle at: 2,000-3,000 rpm
4. About a quarter minute after the engine starts, push the choke lever (1) forward all the way to Fully OFF (B).
5. If idling is unstable, open the throttle slightly.

High Air Temperature35 °C (95 °F) or above

1. Do not use the choke.
2. Open the throttle slightly.
3. Start the engine.

Low Air Temperature10 °C (50 °F) or below

1. Follow steps 1-2 under "Normal Air Temperature".
2. When engine rpm begins to pick up, operate the choke lever to keep fast idle at : 2,000-3,000 rpm
3. Continue warming up the engine until it runs smoothly and responds to the throttle when the choke lever(1) is at Fully OFF (B).

**NOTICE**

Extended use of the choke may impair piston and cylinder wall lubrication.

Snapping the throttle or fast idling for more than about 5 minutes at normal air temperature may cause exhaust pipe discoloration.



**Flooded Engine**

If the engine fails to start after repeated attempts, it may be flooded with excess fuel. To clear a flooded engine, leave the engine stop on RUN and push the choke lever forward to Fully OFF (B). Open the throttle fully and crank the engine for 5 seconds. If the engine starts, quickly close the throttle, then open it slightly if idling is unstable. If the engine does not start, wait 10 seconds, then follow the "High Air Temperature" Starting Procedure (page 56).

**BREAK-IN**

During initial break-in, newly machined surfaces will be in contact with each other and these surfaces will wear in quickly. Break-in maintenance at 600 miles (1,000 km) is designed to compensate for this initial minor wear. Timely performance of the break-in maintenance will ensure optimum service life and performance from the engine.

The general rules are as follows:

- 1 Never lug the engine with full throttle at low engine speeds. This rule is applicable not only during break-in but at all times.
- 2 Maximum continuous engine speed during the first 600 miles (1,000 km) must not exceed 5,000 rpm.
- 3 Increase the maximum continuous engine speed by 2,000 rpm between odometer readings of 600 miles (1,000 km) and 1,000 miles (1,600 km). Drive briskly, vary speeds frequently and use full throttle for short bursts only. Do not exceed 7,000 rpm.
- 4 Upon reaching an odometer reading of 1,000 miles (1,600 km), you can subject the motorcycle to full throttle operation. However, do not exceed 11,500 RPM at any time (tachometer red zone limit).

**SHIFTING**

Review Motorcycle Safety (pages 1 - 10) before you ride.

Proper shifting will provide better fuel economy. When changing gears under normal conditions, use these recommended shift points:

Shifting Up:

From 1st to 2nd:	12 mph (20 km/h)
From 2nd to 3rd:	19 mph (30 km/h)
From 3rd to 4th:	25 mph (40 km/h)
From 4th to 5th:	31 mph (50 km/h)
From 5th to 6th:	37 mph (60 km/h)

Shifting Down:

From 6th to 5th:	28 mph (45 km/h)
From 5th to 4th:	22 mph (35 km/h)
From 4th to 3rd:	16 mph (25 km/h)

Disengage the clutch when speed drops below 11 mph (18 km/h), when engine roughness is evident, or when engine stalling is imminent; shift down to 1st gear for acceleration.

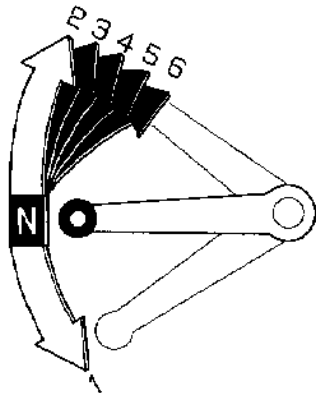

Shifting pattern

To shift properly, pull the clutch lever and close the throttle. Improper shifting may damage the engine and drive train.

Downshifting allows you to use engine braking and lower gearing to decelerate, but downshifting when engine speed is near its allowable maximum may over-rev the engine and cause possible damage.

The battery will not be charged while the engine speed is near idle speed. Avoid idling for prolonged periods.

Do not tow the motorcycle or coast for long distances while the engine is off. The transmission will not be properly lubricated and damage may result.

**BRAKING**

For normal braking, apply both the brake pedal and lever while down-shifting to match your road speed. For maximum braking, close the throttle and firmly apply the pedal and lever; pull in the clutch lever before coming to a complete stop to prevent stalling the engine.

**Important Safety Reminders:**

- Independent operation of only the brake lever or brake pedal reduces stopping performance.
- Extreme application of the brake controls may cause wheel lock, reducing control of the motorcycle.
- When possible, reduce speed or brake before entering a turn; closing the throttle or braking in mid-turn may cause wheel slip. Wheel slip will reduce control of the motorcycle.
- When riding in wet or rainy conditions, or on loose surfaces, the ability to maneuver and stop will be reduced. All of your actions should be smooth under these conditions. Rapid acceleration, braking or turning may cause loss of control. For your safety, exercise extreme caution when braking, accelerating or turning.
- When descending a long, steep grade, use engine compression braking by down shifting, with intermittent use of both brakes. Continuous brake application can overheat the brakes and reduce their effectiveness.
- Riding with your foot resting on the brake pedal or your hand on the brake lever may actuate the brakelight, giving a false indication to other drivers. It may also overheat the brakes, reducing effectiveness.

## HIGH ALTITUDE RUNNING

### (USA ONLY)

When operating this motorcycle at high altitude, the air-fuel mixture becomes overly rich.

Above 6,500 feet (2,000 m), driveability and performance may be reduced and fuel consumption increased. The carburetor can be modified to compensate for this high altitude richness.

However, the carburetor must be returned to standard factory specifications when lower altitude riding is desired. See your authorized Honda dealer for high altitude modification.

#### **NOTICE**

Sustained operation at altitudes below 5,000 feet (1,500 m) with high altitude carburetor modifications may cause engine overheating and damage.

**PARKING**

1. After stopping the motorcycle, shift the transmission into neutral, turn the ignition switch OFF, turn the handlebar all the way to the left and remove the key.
2. Use the center stand to support the motorcycle while parked.

Park the motorcycle on firm, level ground to prevent it from falling over.

If you must park on a slight incline, aim the front of the motorcycle uphill to reduce the possibility of rolling off the center stand or overturning.

3. Lock the steering to help prevent theft (page 43).

**ANTI-THEFT TIPS**

1. Always lock the steering and never leave the key in the ignition switch. This sounds simple but people do forget.
2. Be sure the registration information for your motorcycle is accurate and current.
3. Park your motorcycle in a locked garage whenever possible.
4. Use an additional anti-theft device of good quality. When you park your motorcycle, we recommend that you secure it by using the securing point (1) and a commercially available chain and lock or equivalent. (The rear fender has a storage compartment for a U-shaped lock; see page 47).
5. Put your name, address and phone number in this Owner's Manual and keep it on your motorcycle at all times. Many times stolen motorcycles are identified by information in the Owner's Manuals that are still with them.

NAME: \_\_\_\_\_

ADDRESS: \_\_\_\_\_

PHONE NO: \_\_\_\_\_

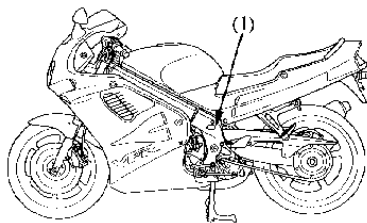

(1) Securing point



## MAINTENANCE

### THE IMPORTANCE OF MAINTENANCE

A well-maintained motorcycle is essential for safe, economical and trouble-free riding. It will also help reduce air pollution.

To help you properly care for your motorcycle, the following pages include a Maintenance Schedule and a Maintenance Record for regularly scheduled maintenance.

These instructions are based on the assumption that the motorcycle will be used exclusively for its designed purpose. Sustained high speed operation or operation in unusually wet or dusty conditions will require more frequent service than specified in the Maintenance Schedule. Consult your authorized Honda dealer for recommendations applicable to your individual needs and use.

If your motorcycle overturns or becomes involved in a crash, be sure your Honda dealer inspects all major parts, even if you are able to make some repairs.

### WARNING

Improperly maintaining this motorcycle or failing to correct a problem before riding can cause a crash in which you can be seriously hurt or killed.

Always follow the inspection and maintenance recommendations and schedules in this owner's manual.

**MAINTENANCE SAFETY**

This section includes instructions on some important maintenance tasks. You can perform some of these tasks with the tools provided - if you have basic mechanical skills.

Other tasks that are more difficult and require special tools are best performed by professionals. Removing the wheels should normally be handled only by a Honda technician or other qualified mechanic; instructions are included in this manual only to assist in emergency service.

Some of the most important safety precautions follow. However, we cannot warn you of every conceivable hazard that can arise in performing maintenance. Only you can decide whether or not you should perform a given task.

**WARNING**

Failure to properly follow maintenance instructions and precautions can cause you to be seriously hurt or killed.

Always follow the procedures and precautions in this owner's manual.

## SAFETY PRECAUTIONS

- Make sure the engine is off before you begin any maintenance or repairs. This will help eliminate several potential hazards:
  - **Carbon monoxide poisoning from engine exhaust.** Be sure there is adequate ventilation whenever you operate the engine.
  - **Burns from hot parts.** Let the engine and exhaust system cool before touching.
  - **Injury from moving parts.** Do not run the engine unless instructed to do so.
- Read the instructions before you begin, and make sure you have the tools and skills required.
- To help prevent the motorcycle from falling over, park it on a firm, level surface, using the center stand to provide support.

- To reduce the possibility of a fire or explosion, be careful when working around gasoline or batteries. Use only non-flammable solvent, not gasoline, to clean parts. Keep cigarettes, sparks and flames away from the battery and all fuel-related parts.

Remember that your authorized Honda dealer knows your motorcycle best and is fully equipped to maintain and repair it.

To ensure the best quality and reliability, use only new genuine Honda parts or their equivalents for repair and replacement.

If you have the tools and skills required for additional maintenance jobs, you can purchase Honda's Common Service Manual and an official. Model Specific Service Manual from your Honda dealer (page 116).

## **EMISSION REQUIREMENTS (USA ONLY)**

The U.S. Environmental Protection Agency and California Air Resources Board (CARB) require that your motorcycle comply with applicable exhaust emissions standards during its useful life, when operated and maintained according to the instructions provided, and that motorcycles built after January 1, 1983 comply with applicable noise emission standards for one year or 6,000 km (3,730 miles) after the time of sale to the ultimate purchaser, when operated and maintained according to the instructions provided. Compliance with the terms of the Distributor's Warranties for Honda Motorcycle Emission Control Systems is necessary in order to keep the emissions system warranty in effect.

The Vehicle Emission Control Information Label (1) is attached to the rear fender below the seat.

The Vacuum Hose Routing Diagram Label (2) is attached to the rear fender below the seat (California ONLY).

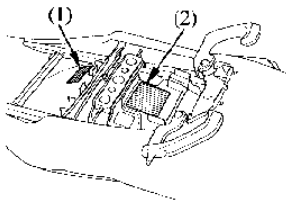

- (1) Vehicle Emission Control Information Label
- (2) Vacuum Hose Routing Diagram Label

## MAINTENANCE SCHEDULE

Perform the Pre-ride Inspection (page 52) at each scheduled maintenance period.

Each item on the maintenance schedule requires some mechanical knowledge. Certain items (particularly those marked \* and \*\*) may require more technical information and tools. Consult your authorized Honda Dealer.

- Should be serviced by your authorized Honda dealer, unless the owner has proper tools, service data and is mechanically qualified. Refer to Honda's Common Service Manual and an official Model Specific Service Manual.
- In the interest of safety, we recommend these items be serviced only by your authorized Honda dealer.

Summary of Maintenance Schedule Notes and Procedures:

- NOTE:
- (1) At higher odometer readings, repeat at the frequency interval established here.
  - (2) Service more frequently when riding in unusually wet or dusty areas.
  - (3) Replace every 2 years, or at indicated odometer interval, whichever comes first. Replacement requires mechanical skill.
  - (4) California type only.

Maintenance Procedures:

- I: Inspect and Clean, Adjust, Lubricate or Replace if necessary  
 C: Clean  
 A: Adjust  
 L: Lubricate  
 R: Replace

FREQUENCY		NOTE	ODOMETER READING [NOTE (1)]								Refer to page
			× 1,000 mi	0.6	4	8	12	16	20	24	
ITEM			× 1,000 km	1	6.4	12.8	19.2	25.6	32.0	38.4	
E M I S S I O N  R E L A T E D  I T E M S	* FUEL LINE					I		I		I	—
	* THROTTLE OPERATION					I		I		I	83
	* CARBURETOR CHOKE					I		I		I	—
	* AIR CLEANER	NOTE (2)					R			R	—
	SPARK PLUG				I	R	I	R	I	R	80
	* VALVE CLEARNCE							I			—
	ENGINE OIL			R		R		R		R	33, 76
	ENGINE OIL FILTER			R		R		R		R	77
	* CARBURETOR SYNCHRONIZATION					I		I		I	—
	* ENGINE IDLE SPEED			I	I	I	I	I	I	I	84
	RADIATOR COOLANT	NOTE (3)				I		I		R	28, 85
	* COOLING SYSTEM					I		I		I	—
	* SECONDARY AIR SUPPLY SYSTEM					I		I		I	—
* EVAPORATIVE EMISSION CONTROL SYSTEM	NOTE (4)					I			I	—	

FREQUENCY		NOTE	ODOMETER READING [NOTE (1)]							Refer to page	
			× 1,000 mi	0.6	4	8	12	16	20		24
ITEM			× 1,000 km	1	6.4	12.8	19.2	25.6	32.0	38.4	
NON- MISSION RELATED ITEMS	DRIVE CHAIN		I, L EVERY 600 mi (1,000 km)							86	
	BRAKE FLUID	NOTE (3)		I	I	R	I	I	R	23	
	BRAKE PAD WEAR			I	I	I	I	I	I	91	
	BRAKE SYSTEM		I		I		I		I	23, 91	
	* BRAKE LIGHT SWITCH				I		I		I	—	
	* HEADLIGHT AIM				I		I		I	—	
	CLUTCH SYSTEM				I		I		I	26	
	CLUTCH FLUID	NOTE (3)			I	I	R	I	I	R	—
	SIDE STAND					I		I		I	93
	* SUSPENSION					I		I		I	—
	* NUTS, BOLTS, FASTENERS			I		I		I		I	—
	** WHEELS/TIRES					I		I		I	—
	** STEERING HEAD BEARINGS			I		I		I		I	—

**MAINTENANCE RECORD**

<b>Miles</b>	<b>(km)</b>	<b>Performed By</b>	<b>Odometer</b>	<b>Date</b>
600	(1,000)	_____	_____	_____
4,000	(6,400)	_____	_____	_____
8,000	(12,800)	_____	_____	_____
12,000	(19,200)	_____	_____	_____
16,000	(25,600)	_____	_____	_____
20,000	(32,000)	_____	_____	_____
24,000	(38,400)	_____	_____	_____
28,000	(44,800)	_____	_____	_____
32,000	(51,200)	_____	_____	_____
36,000	(57,600)	_____	_____	_____
40,000	(64,000)	_____	_____	_____
44,000	(70,400)	_____	_____	_____
48,000	(76,800)	_____	_____	_____

- Make sure whoever performs the maintenance completes this record. All scheduled maintenance, including the 600 mile(1,000 km) break-in maintenance, is considered a normal owner operating cost and will be charged for by your dealer.
- Detailed receipts verifying the performance of required maintenance should be retained. These receipts should be transferred with the motorcycle to the new owner if the motorcycle is sold.



**TOOL KIT**

The tool kit (1) is in the tool kit compartment (2) under the seat (page 45).

Some roadside repairs, minor adjustments and parts replacement can be performed with the tools contained in the kit.

- Pin spanner
- 14 x 17 mm box end wrench
- 10 x 12 mm box end wrench
- 8 x 12 mm open end wrench
- 10 x 14 mm open end wrench
- Pliers
- No.2 Phillips screwdriver
- No.2 screwdriver
- Screwdriver grip
- 8 mm box wrench
- 5 mm hex wrench
- 22 mm box end wrench
- 16 mm box end wrench
- Feeler gauge 0.7 mm
- Tool bag

The following tools are also provided with your motorcycle.

- Wheel wrench
- Extension bar

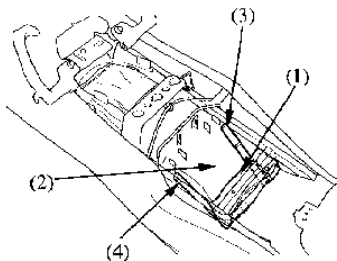

- |                          |                   |
|--------------------------|-------------------|
| (1) Tool kit             | (3) Extension bar |
| (2) Tool kit compartment | (4) Wheel wrench  |

**SERIAL NUMBERS**

The frame and engine serial numbers are required when registering your motorcycle. They may also be required by your dealer when ordering replacement parts. Record the numbers here for your reference.

VIN \_\_\_\_\_

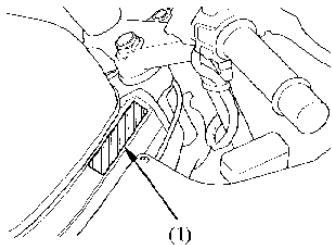

(1) VIN

The VIN, Vehicle Identification Number(1), is on the Safety Certification Label affixed to the right side of the frame near the steering head. The frame number (2) is stamped on the right side of the steering head.

FRAME NO. \_\_\_\_\_

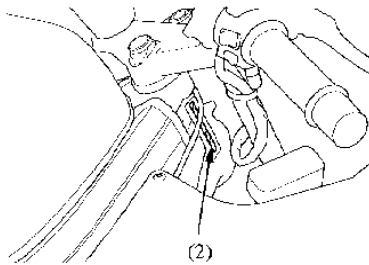

(2) Frame number

The engine number (3) is stamped on top of the crankcase.

ENGINE NO. \_\_\_\_\_

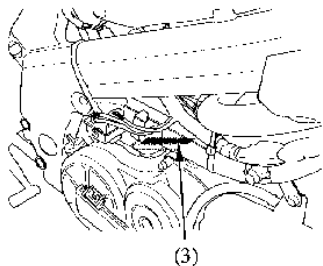

(3) Engine number

### COLOR LABEL

The color label (1) is attached to the frame under the seat.

Remove the side cover.

It is helpful when ordering replacement parts.

Record the color and code here for your reference.

COLOR \_\_\_\_\_

CODE \_\_\_\_\_

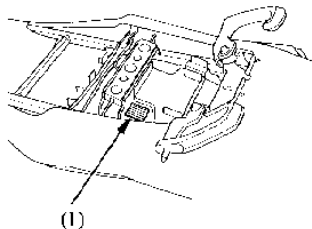

(1) Color label

## ENGINE OIL

Refer to the Safety Precautions on page 67

### Engine Oil Recommendation:

**USE PRO HONDA GN4**

**4 STROKE OIL OR AN EQUIVALENT**

Do not use oils with graphite or molybdenum additives. They may adversely affect clutch operation.

Use only high detergent, premium quality motor oil certified to meet API Service Classification SF or SG.

Motor oils intended for Service SF or SG will show this designation on the container. The use of special oil additives is unnecessary and will only-increase operating expenses.

Engine oil is a major factor affecting the performance and service life of the engine. Non-detergent, vegetable or castor-based racing oils are not recommended.

## Recommended Oil Viscosity

### SAE 10W-40

Other viscosity's shown in the chart below may be used when the average temperature in your riding area is within the indicated range.

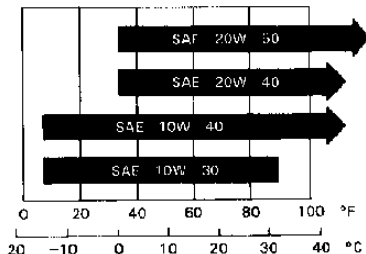

## **Engine Oil and Filter**

Engine oil quality is the chief factor affecting engine service life. Change the engine oil as specified in the maintenance schedule (page 70).

When running in very dusty conditions, oil changes should be performed more frequently than specified in the maintenance schedule.

Please dispose of used engine oil in a manner that is compatible with the environment. We suggest you take it in a sealed container to your local recycling center or service station for reclamation. Do not throw it in the trash or pour it on the ground or down a drain.

Changing the oil filter requires a special oil filter tool and a torque wrench. If you do not have these tools and the necessary skill, we recommend that you have your authorized Honda dealer perform this service.

If a torque wrench is not used for this installation, see your authorized Honda dealer as soon as possible to verify proper assembly.

Change the engine oil with the engine at normal operating temperature and the motorcycle on its side stand to assure complete and rapid draining.

1. Remove the middle fairing(page 50).
2. To drain the oil, remove the oil filler cap and crankcase drain plug(1) and sealing washer (2).

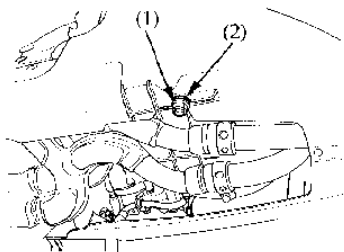

(1) Crankcase drain plug (2) Sealing washer

3. Remove the oil filter (3) with a filter wrench and let the remaining oil drain out. Discard the oil filter (3).

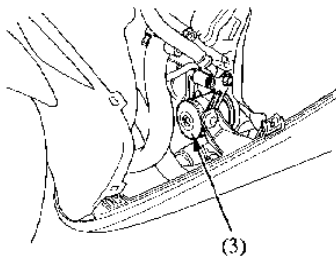

(3) Oil filter

4. Apply a thin coat of engine oil to the new oil filter rubber seal (4).
5. Using a special tool and a torque wrench, install the new oil filter and tighten to a torque of:  
**10 N·m(1.0 kg-m, 7 lb-ft)**  
 Use only the Honda genuine oil filter or a filter of equivalent quality specified for your model. Using the wrong Honda filter or a non-Honda filter which is not of equivalent quality may cause engine damage.

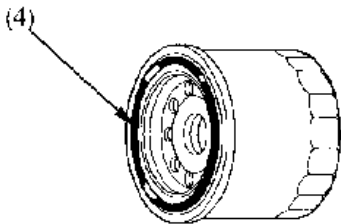

(4) Oil filter rubber seal

6. Check that the sealing washer on the drain plug is in good condition and install the plug. Replace the sealing washer every other time the oil is changed, or each time if necessary.  
 Oil Drain Plug Torque:  
**38 N·m(3.8 kg-m, 27 lb-ft)**
7. Fill the crankcase with the recommended grade oil; approximately:  
**3.1 Lt (3.3 USqt, 2.7 Imp qt)**
8. Install the oil filler cap.
9. Start the engine and let it idle for 2-3 minutes.
10. Several minutes after stopping the engine, check that the oil level is at the upper level mark on the dipstick with the motorcycle upright on firm, level ground. Make sure there are no oil leaks.

**SPARK PLUGS**

Refer to the Safety Precautions on page 67.

Recommended plugs:

Standard:

CR9EH-9 (NGK) or  
U27FER 9 (NIPPONDENSO)

For cold climate: (Below 5°C, 41°F)

CR8EH-9 (NGK) or  
U24FER 9 (NIPPONDENSO)

**NOTICE**

Never use a spark plug with an improper heat range. Severe engine damage could result.

**Access to rear cylinder spark plugs:**

1. Remove the side cover (page 51).

**Access to front cylinder spark plugs:**

1. Remove both side of the middle fairing (page 50).
2. Remove the mounting bolt(1) attaching the bottom of the radiator (2).
3. Remove the oil hose (3) from the radiator clamps (4).
4. Raise the radiator.

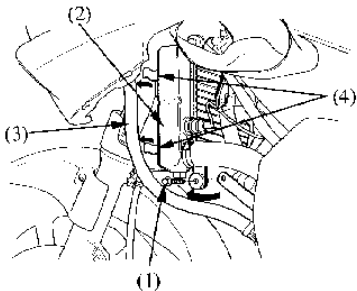

- |                   |              |
|-------------------|--------------|
| (1) Mounting bolt | (3) Oil hose |
| (2) Radiator      | (4) Clamps   |



**Inspection**

1. Disconnect the spark plug caps from the spark Plugs.
2. Clean any dirt from around the spark plug bases. Remove the spark plugs using the spark plug wrench (5) furnished in the tool kit.

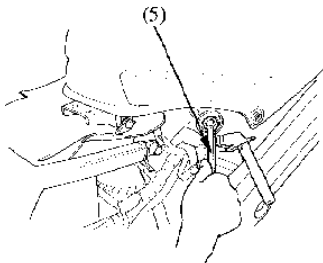

(5) Spark plug wrench

3. Inspect the electrodes and center porcelain for deposits, corrosion or carbon fouling. If the corrosion or deposit is heavy, replace the plug. Clean a carbon-or wet-fouled plug with a plug cleaner, otherwise use a wire brush.
4. Check the spark plug gap (6) using a wire type feeler gauge. If adjustment is necessary, bend the side electrode (7) carefully.

The gap should be:  
0.80-0.90 mm(0.031-0.035 in)

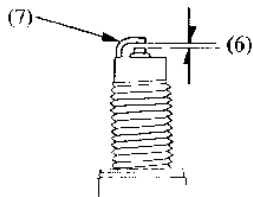

(6) Spark plug gap

(7) Side electrode

5. With the plug washer attached, thread the spark plug in by hand to prevent cross threading.
6. Tighten a new spark plug 1/2 turn with a spark plug wrench to compress the washer. If you are reusing a plug, it should only take 1/8 - 1/4 turn after the plug seats.

**NOTICE**

The spark plug must be securely tightened. An improperly tightened plug can become very hot and possibly damage the engine.

7. Reinstall the spark plug caps.
8. Install the removed parts in reverse order of removal.

## THROTTLE OPERATION

Refer to the Safety Precautions on page 67.

1. Check for smooth rotation of the throttle grip from the fully open to the fully closed position at both full steering positions.
2. Measure the throttle grip free play at the throttle grip flange. The standard free play should be approx:  
2-6 mm(0.08-0.24 in)

To adjust play, loosen the lock nut (1) and turn the adjuster (2).

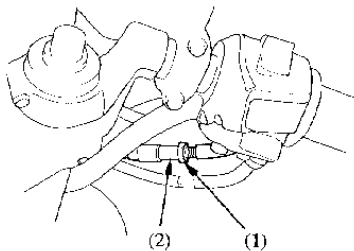

(1) Lock nut

(2) Adjuster

**IDLE SPEED**

Refer to the Safety Precautions on page 67.

The engine must be at normal operating temperature for accurate idle speed adjustment. Ten minutes of stop-and-go riding is sufficient.

Do not attempt to compensate for faults in other systems by adjusting idle speed. See your authorized Honda dealer for regularly scheduled carburetor adjustments.

1. Warm up the engine, shift to neutral and place the motorcycle on its stand.
2. Adjust idle speed with the throttle stop screw (1).

Idle speed (in neutral):

1,100 +/- 100 rpm

1,200 +/- 100 rpm ... California only

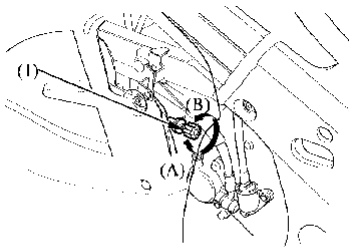

(1) Throttle stop screw

(A) Increase

(B) Decrease

**COOLANT**

Refer to the Safety Precautions on page 67.

**Coolant Replacement**

Coolant should be replaced by an authorized Honda dealer, unless the owner has proper tools and service data and is mechanically qualified. Refer to Honda's Common Service Manual and an official Model Specific Service Manual.

Always add coolant to the reserve tank. Do not attempt to add coolant by removing the radiator cap.

**WARNING**

Removing the radiator cap while the engine is hot will allow the coolant to spray out, seriously scalding you.

Always let the engine and radiator cool down before removing the radiator cap.

## DRIVE CHAIN

Refer to the Safety Precautions on page 67 .

The service life of the drive chain is dependent upon proper lubrication and adjustment. Poor maintenance can cause premature wear or damage to the drive chain and sprockets. The drive chain should be checked, adjusted and lubricated as part of the Pre-ride Inspection (page 52).

Under severe usage, or when the motorcycle is ridden in unusually dusty or muddy areas, more frequent maintenance will be necessary.

### Inspection:

1. Turn the engine off, place the motorcycle on the side stand and shift the transmission into Neutral.
2. Check slack in the lower drive chain run midway between the sprockets. Drive chain slack should be adjusted to allow the following vertical movement by hand: 15-25 mm(0.6-1.0 in)

3. Roll the motorcycle forward. Stop. Check drive chain slack. Repeat this procedure several times. Drive chain slack should remain constant. If the chain is slack only in certain sections, some links are kinked and binding. Binding and kinking can frequently be eliminated by lubrication.

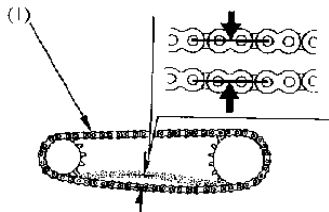

(1) Drive chain

4. Roll the motorcycle forward. Stop and place it on its side stand. Inspect the drive chain and sprockets for any of the following conditions:

#### DRIVECHAIN

- \* Damaged Rollers
- \* Loose Pins
- \* Dry or Rusted Links
- \* Kinked or Binding Links
- \* Excessive Wear
- \* Improper Adjustment
- \* Missing O-rings

#### SPROCKETS

- \* Excessively Worn Teeth
- \* Broken or Damaged Teeth

A drive chain with damaged rollers, loose pins, or missing O-rings must be replaced. A chain which appears dry, or shows signs of rust, requires supplementary lubrication. Kinked or binding links should be thoroughly lubricated and worked free. If links cannot be freed, the chain must be replaced.

Damaged Sprocket  
Teeth

**Replace**

Worn Sprocket  
Teeth

**Replace**

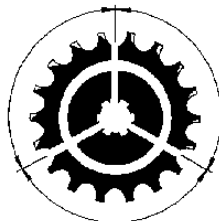

Normal Sprocket Teeth

**GOOD**

**Adjustment:**

Drive chain slack should be checked and adjusted, if necessary, every 600 miles (1,000 km). When operated at sustained high speeds or under conditions of frequent rapid acceleration, the chain may require more frequent adjustment.

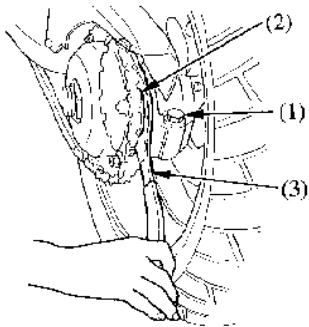

- (1) Bearing holder pinch bolt
- (2) Bearing holder
- (3) Pin spanner

If the drive chain requires adjustment, the procedure is as follows:

1. Turn the engine off, place the motorcycle on its center stand and shift the transmission into neutral.
2. Loosen the bearing holder pinch bolt (1).
3. Turn the bearing holder (2) clockwise or counterclockwise to obtain the proper chain slack with the pin spanner (3).
4. Torque the bearing holder pinch bolt to: 55 Nm(5.5 kg-m, 40 lb-ft)
5. Recheck chain slack. Chain slack should be: 15-25 mm(0.6-1.0 in)



Wear inspection

Check the chain wear label when adjusting the chain. If the red zone (4) on the label aligns with the tip of driven sprocket teeth (5) after the chain has been adjusted to the proper slack, the chain is excessively worn and must be replaced. The proper slack is:

15-25 mm(0.6-1.0 in)

Damage to the bottom part of the frame may be caused by excessive drive chain slack of more than:

40 mm(1.6in)

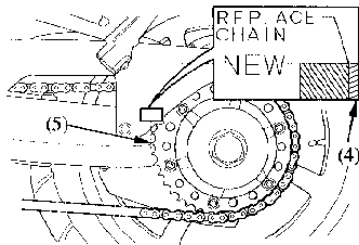

(4) Red zone

(5) Tip of driven sprocket teeth

Lubrication and cleaning:

Lubricate every 600 miles (1,000 km) or sooner if chain appears dry.

The drive chain on this motorcycle is equipped with small O-rings between the link plates. These O-rings retain grease inside the chain to improve its service life.

The O-rings in this chain can be damaged by steam cleaning, high pressure washers, and certain solvents. Clean the chain with high flashpoint solvent, such as kerosene.

Wipe dry and lubricate only with SAE 80 or 90 gear oil. Commercial chain lubricants may contain solvents which could damage the rubber O-rings.

Replacement Chain:

**DID50V4 or RK50MFOZ1**

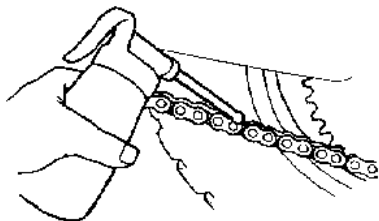

**BRAKE PAD WEAR**

Refer to the Safety Precautions on page 67.

Brake pad shoe wear depends upon the severity of usage, the type of riding, and road conditions.

(Generally, the pads/shoes will wear faster on wet and dirty roads.)

Inspect the pads/shoes at each regular maintenance interval (page 71).

**Front Brake**

Check the cutout (1) in each pad.

If either pad is worn to the cutout, replace both pads as a set. See your authorized Honda dealer for this service.

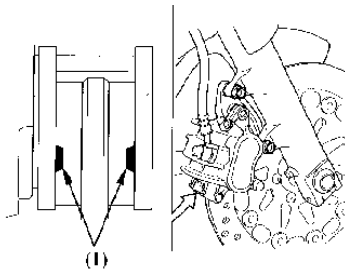

(1) Cutouts

**Rear Brake**

Check the cutout (2) in each pad.

If either pad is worn to the cutout, replace both pads as a set. See your authorized Honda dealer for this service.

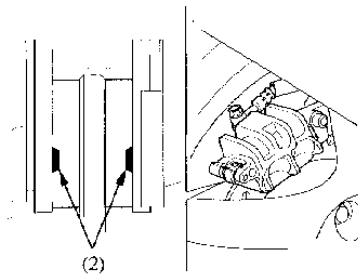

(2) Cutouts

**SIDE STAND**

Refer to the Safety Precautions on page 67.

Check the side stand system for proper function.

- Check the spring (1) for damage or loss of tension and the side stand assembly for freedom of movement.
- Check the side stand ignition cut-off system:
  1. Sit astride the motorcycle: put the side stand up
  2. stand up and the transmission in neutral.
  3. Start the engine and with the clutch lever pulled in, shift the transmission into gear.
  4. Lower the side stand. The engine should stop as you put the side stand down.

If the side stand system does not operate as described, see your authorized Honda dealer for service.

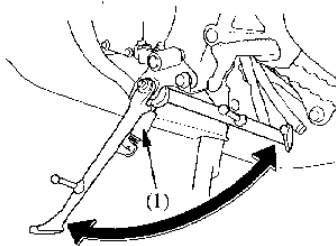

(1) Side stand spring

## WHEEL REMOVAL

Refer to the Safety Precautions on page 67 .

### Front Wheel Removal

1. Raise the front wheel off the ground by placing a support block under the engine.
2. Remove the right and left caliper assemblies (1) from the fork legs by removing the fixing bolts (2).

To avoid damage to the brake hose, support the caliper assembly so that it doesn't hang from the hose. Do not twist the brake hose.

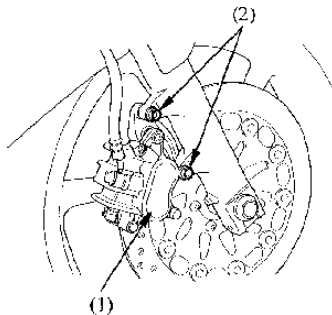

- (1) Brake caliper assembly  
(2) Fixing bolts

Do not depress the brake lever when the wheel is off the motorcycle. The caliper pistons will be forced out of the cylinders with subsequent loss of brake fluid. If this occurs, servicing of the brake system will be necessary. See your authorized Honda dealer for this service.

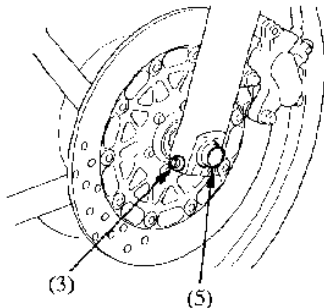

- (3) Axle pinch bolts
- (4) Axle bolt
- (5) Front axle

3. Loosen the right and left axle pinch bolts (3) and remove the axle bolt (4).
4. Remove the front axle (5) and the wheel.

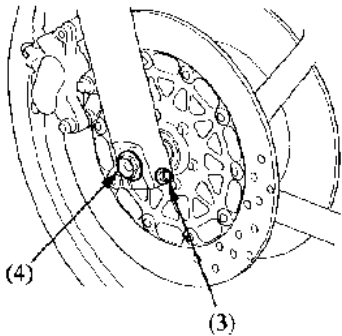

Installation Notes:

Reverse the removal procedure to install the wheel.

If a torque wrench was not used for installation, see your authorized Honda dealer as soon as possible to verify proper assembly. Improper assembly may lead to loss of braking capacity.

- Position the wheel between the fork legs and insert the front axle shaft from the left side, through the left fork leg and wheel hub.
- When installing the wheel, fit the left brake disc carefully between the brake pads to avoid damaging the pads.
- Tighten the axle bolt to the specified torque. Axle bolt torque: 59 Nm(5.9 kg-m, 43 lb-ft)
- Tighten all the axle pinch bolts to the specified torque. Axle pinch bolts torque: 22 Nm(2.2 kg-m, 16 lb-ft)

- Install the caliper fixing bolts, and tighten to a torque of: 27 Nm(2.7 kg-m, 20 lb-ft)

Check the clearance (6) between the brake disc



(7) and the caliper bracket (8) on each side with a 0.7 mm feeler gauge (9) after installation. The clearance should be at least 0.7 mm (0.03 in).

If the clearance is not 0.7 mm (0.03 in) or more, loosen the left axle pinch bolt and pull the left fork outward or push inward adjust the clearance. Then tighten the axle pinch bolt to the specified torque.

Axle pinch bolt torque:

22 N-m(2.2 kg-m, 16 lb-ft)

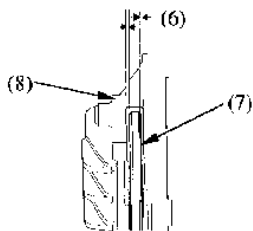

(6) Clearance

(8) Caliper bracket

(7) Brake disc

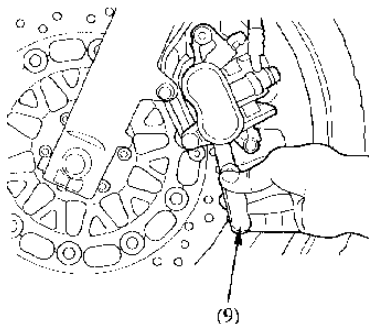

(9) Feeler gauge

Apply the front brake several times, then recheck both discs for caliper bracket-to-disc clearance. Do not operate the motorcycle without adequate clearance.

Failure to provide adequate disc-to-caliper bracket clearance may damage the brake discs and impair braking efficiency.

- Check for free wheel rotation after the brake is released. Recheck the wheel if the brake drags or if the wheel does not rotate freely.

### Rear Wheel Removal

1. Place the motorcycle on its center stand.
2. Loosen the muffler clamp bolts (1).
3. Remove the muffler mounting bolt (2) and slide the muffler to a side as shown.
4. Remove the four rear wheel nuts (3).
5. Remove the rear wheel (4) slowly.

Do not depress the brake pedal while the wheel is off the motorcycle. The caliper pistons will be forced out of the cylinders with subsequent loss of brake fluid. If this occurs, servicing of the brake system will be necessary. See your authorized Honda dealer for this service.

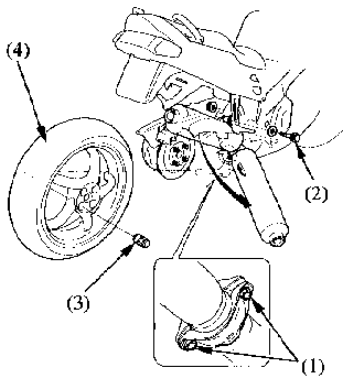

- |                           |                     |
|---------------------------|---------------------|
| (1) Muffler clamp bolts   | (3) Rear wheel nuts |
| (2) Muffler mounting bolt | (4) Rear wheel      |

**Installation Notes:**

Reverse the removal procedure to install the wheel.

If a torque wrench was not used for installation, see your authorized Honda dealer as soon as possible to verify proper assembly. Improper assembly may lead to loss of braking capacity.

- Tighten the rear wheel nuts to the specified torque. Rear wheel nuts torque: 103 N·m(10 kg·m, 75 lb·ft)
- Check the clearance (5) between the rear tire and the muffler. The clearance should be: 25-35 mm(1.0-1.4 in)
- After installing the wheel, apply the brake several times and then check if the wheel rotates freely. Recheck the wheel if the brake drags or if the wheel does not rotate freely.
- Operate the brake pedal and check the brake operation.

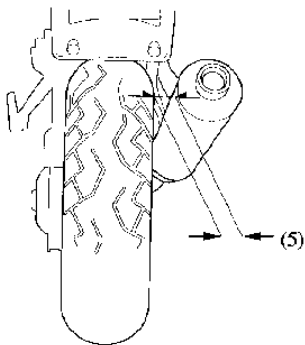

(5) Clearance

**BATTERY**

Refer to the Safety Precautions on page 67.

It is not necessary to check the battery electrolyte level or add distilled water as the battery is a maintenance-free (sealed) type. If your battery seems weak and/or is leaking electrolyte (causing hard starting or other electrical troubles), contact your authorized Honda dealer.

**NOTICE**

Your battery is a maintenance free type and can be permanently damaged if the caps are removed.

**WARNING**

The battery contains sulfuric acid (electrolyte) which is highly corrosive and poisonous.

Getting electrolyte in your eyes or on your skin can cause serious burns.

Wear protective clothing and eye protection when working near the battery.

**KEEP CHILDREN AWAY FROM THE BATTERY.**

**Emergency Procedures**

**Eyes** - Flush with water from a cup or other container for at least fifteen minutes. (Water under pressure can damage the eye.) Immediately call 911 (U.S. only) or a physician.

**Skin** - Remove contaminated clothing. Flush the skin with large quantities of water. Call a physician immediately.

**Swallowing** - Drink water or milk. Call your local Poison Control Center (U.S. only) or a physician immediately.

### Battery Removal

The battery is in the battery box below the seat.

1. Remove the seat (page 45).
2. Release the rings and remove the rubber band(1).
3. Disconnect the negative(-) terminal lead (2) from the battery first, then disconnect the positive(+) terminal lead (3).
4. Pull out the battery (4)from the battery box.

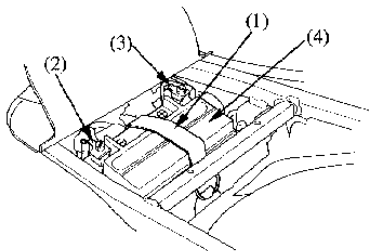

- (1) Rubber band
- (2) Negative ( - ) terminal lead
- (3) Positive ( + ) terminal lead
- (4) Battery

## FUSES

Refer to the Safety Precautions on page 67.

All of the electrical circuits on your motorcycle have fuses to protect them from a short circuit or overload.

### Checking and Replacing Fuses

If something electrical on your motorcycle stops working, the first thing you should check for is a blown fuse. Determine from the chart on the circuit fuse box cover which fuse or fuses control that component. Check those fuses first, but check all the fuses before deciding that is not the cause. Replace any blown fuses (1) and check the component's operation.

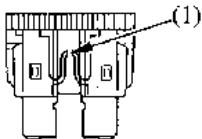

(1) **Blown fuse**

If you cannot ride the motorcycle without fixing the problem, and you do not have a spare fuse, take a fuse of the same rating or a lower rating from one of the other circuits. Make sure you can do without that circuit temporarily. If you replace a blown fuse with a spare fuse that has a lower rating, replace the fuse with the correct rating as soon as you can.

If the replacement fuse of the same rating burns out in a short time, there is probably a serious electrical problem on your motorcycle. Leave the blown fuse in that circuit and have your motorcycle checked by a qualified technician.

#### NOTICE

Replacing a fuse with one that has a higher rating greatly increases the chances of damaging the electrical system. If you do not have a replacement fuse with the proper rating for the circuit, install one with a lower rating.



**Fuse box:**

The fuse box (1) is located near the right upper shroud (2).

The specified fuses are:

10A, 20A

1. Turn the ignition switch OFF before checking or replacing a fuse to prevent an accidental short circuit.

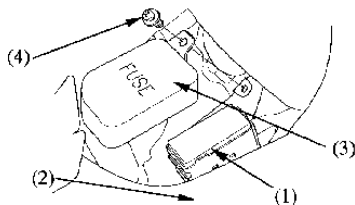

- |                        |                         |
|------------------------|-------------------------|
| (1) Fuse box           | (3) Fuse box case cover |
| (2) Right upper shroud | (4) Screw               |

2. Remove the fuse box case cover (3) by removing the screws (4).
3. Open the fuse box cover (5).
4. Pull out the fuse. If the fuse is blown, install a new fuse. Spare fuses (6) are located in the fuse box.
5. Install the fuse box case cover.

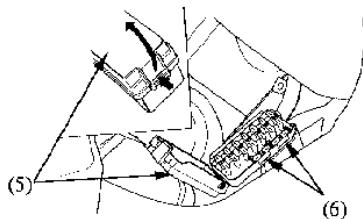

- |                    |
|--------------------|
| (5) Fuse box cover |
| (6) Spare fuses    |

**Main fuse:**

The main fuse (1) is located on the starter magnetic switch near the battery negative (-) terminal lead, is:

**30A**

1. Turn the ignition switch OFF before checking or replacing a fuse to prevent an accidental short circuit.
2. Remove the seat (page 45).
3. Disconnect the wire connector (2) of the starter magnetic switch (3).
4. Pull out the fuse. If the main fuse is blown, install a new fuse. The spare main fuse (4) is located near the starter magnetic switch.
5. Reconnect the wire connector and install the seat.

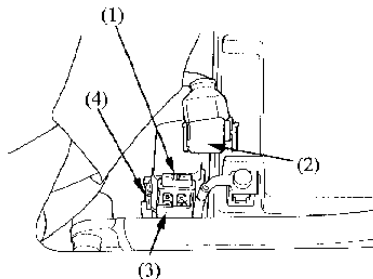

- |                    |                             |
|--------------------|-----------------------------|
| (1) Main fuse      | (3) Starter magnetic switch |
| (2) Wire connector | (4) Spare main fuse         |

## CLEANING

Clean your motorcycle regularly to protect the surface finishes and inspect for damage, wear, and oil, coolant, or brake fluid leakage.

Avoid cleaning products that are not specifically designed for motorcycle or automobile surfaces.

They may contain harsh detergents or chemical solvents that could damage the metal, paint, and plastic on your motorcycle.

If your motorcycle is still warm from recent operation, give the engine and exhaust system time to cool off.

Park in a shady area. Washing your motorcycle in bright sunlight may cause the finish to fade because water droplets intensify the sun's brightness. Spotting is also more likely because surface water can dry before you have time to wipe it off.

We recommend avoiding the use of high pressure water spray (typical in coin-operated car washes.)

### NOTICE

High pressure water (or air) can damage certain parts of the motorcycle

1. Rinse the motorcycle thoroughly with cool water to remove loose dirt.
2. Clean the motorcycle with a sponge or soft cloth using cool water. Avoid directing water to muffler outlets and electrical parts.
3. Clean the windshield with a soft cloth or sponge and plenty of water. Dry with a soft clean cloth. Remove minor scratches with commercially available plastic polishing compound. Replace the windshield if scratches cannot be removed and they obstruct clear vision.

Take care to keep battery electrolyte, brake fluid or other acid chemicals off the fairing. They will damage the plastic.

4. After cleaning, rinse the motorcycle thoroughly with plenty of clean water. Detergent residue can corrode alloy parts.
5. Dry the motorcycle and lubricate the drive chain.
6. Start the engine and let it run for several minutes.
7. Test the brakes before riding the motorcycle. Several applications may be necessary to restore normal braking performance.

Braking efficiency may be temporarily impaired immediately after washing the motorcycle.

Anticipate longer stopping distances to avoid a possible accident.

### **Aluminum Wheel Maintenance**

Aluminum corrodes when it comes in contact with dust, mud, road salt, etc. After riding, clean the wheels with a wet sponge and mild detergent, then rinse well with water and wipe dry with a clean cloth.

Do not use steel wool or a cleaner containing abrasives or compounds to clean the wheels, as they can cause damage.

**STORAGE GUIDE**

Extended storage, such as for winter, requires that you take certain steps to reduce the effects of deterioration from non-use of the motorcycle. In addition, necessary repairs should be made BEFORE storing the motorcycle; otherwise, these repairs may be forgotten by the time the motorcycle is removed from storage.

**STORAGE**

1. Change the engine oil and filter.
2. Make sure the cooling system is filled with a 50/50% antifreeze solution.
3. Fill the fuel tank. Reinstall the fuel fill cap on the tank.
4. Drain the carburetors into an approved gasoline container.

If storage will last more than one month, carburetor draining is very important, to assure proper Performance after storage.

**WARNING**

Gasoline is highly flammable and explosive and you can be burned or seriously injured when handling fuel.

- Stop engine and keep heat, sparks, and flame away.
- Handle fuel only outdoors.
- Wipe up spills immediately.

5. To prevent rusting in the cylinders, perform the following:
  - Remove the spark plug caps from the spark plugs. Using tape or string, secure the caps to any convenient plastic body part so that they are positioned away from the spark plugs.
  - Remove the spark plugs from the engine and store them in a safe place. Do not connect the spark plugs to the spark plug caps.
  - Pour a tablespoon (15--20 cc) of clean engine oil into each cylinder and cover the spark plug holes with a piece of cloth.
  - Crank the engine several times to distribute the oil.
  - Reinstall the spark plugs and spark plug caps.
6. Remove the battery and charge it fully. Store it in an area protected from freezing temperatures and direct sunlight. Slow charge the battery once a month.
7. Wash and dry the motorcycle. Wax all painted surfaces. Coat chrome with rust-inhibiting oil.
8. Lubricate the drive chain.
9. Inflate the tires to their recommended pressures. Place the motorcycle on blocks to raise both tires off the ground.
10. Cover the motorcycle (don't use plastic or other coated materials) and store in an unheated area, free of dampness with a minimum of daily temperature variation. Do not store the motorcycle in direct sunlight.

**REMOVAL FROM STORAGE**

1. Uncover and clean the motorcycle. Change the engine oil if more than 4 months have passed since the start of storage.
2. Charge the battery as required. Install the battery.
3. Perform all Preride Inspection checks (page 52). Test ride the motorcycle at low speeds in a safe riding area away from traffic.

## SPECIFICATIONS

### DIMENSIONS

Over all length	2,125 mm(83.7 in)
Over all width	720 mm(28.3 in)
Over all height	1,185 mm(46.7 in)
Wheelbase	1,470 mm(57.9 in)
Ground clearance	130 mm (5.1 in)

### WEIGHT

Dry weight	211 kg (465 lbs)
	212 kg (467 lbs) ...California only

### CAPACITIES

Engine oil: After draining	2.9 L (3.1 USqt,2.6 Imp qt)
After draining and oil filter change	3.1 L (3.3 USqt,2.7 Imp qt)
After disassembly	3.8 L (4.0 US qt , 3.3 Imp qt)
Fuel tank	21.0 L (5.55 US gal ,4.62 Imp gal)
Cooling system capacity	3.6 L (0.95 US gal , 0.79 Imp gal)
Passenger capacity	Operator and one passenger
Maximum weight capacity	175 kg (386 lbs)



**ENGINE**

Bore and stroke	70.0 x 48.6 mm (2.76 x 1.91 in)
Compression ratio	11.0 : 1
Displacement	748 cm <sup>3</sup> (45.6 cu-in)
Spark plug	
Standard	CR9EH-9 (NGK) or U27FER 9 (NIPPONDENSO)
For cold climate (Below 5°C, 41°F)	CR8EH-9 (NGK) or U24FER 9 (NIPPONDENSO)
Spark plug gap	0.80-0.90 mm (0.031 -0.035 in)
Idle speed	1,100 +/- 100 rpm 1,200 +/- 100 rpm ...California only
Valve clearance (Cold)	
Intake	0.16 mm (0.006 in)
Exhaust	0.25 mm (0.010 in)

**CHASSIS AND SUSPENSION**

Caster	26°
Trail	99 mm(3.9 in)
Tire size, front	120/70 ZR 17
Tire size, rear	170/60 ZR 17

**POWER TRANSMISSION**

Primary reduction	1.939
Gear ratio	1st 2.846
	2nd 2.062
	3rd 1.631
	4th 1.333
	5th 1.153
	6th 1.035
Final reduction	2.687

**ELECTRICAL**

Battery		12V-10AH
Generator		0.37kw 5,000rpm

**LIGHTS**

Headlight		12V-45/45W x 2
Brake / taillight		12V-32/2CP x 2
Position light		12V-8W x 2
License light		12V-8W
Turn signal light	Front	12V-23W
	Rear	12V-23W
Instrument lights		12V-1.7W x 5
Neutral indicator		12V-1.7W
Turn signal indicator		12V-1.7W x 2
High beam indicator		12V-1.7W
Low oil pressure indicator		12V-1.7W
Side stand indicator		12V-1.7W
Fuel indicator		12V-5W

**FUSE**

Main fuse	30A
Other fuses	10A,20A

## CONSUMER INFORMATION SERVICE MANUALS



- The Honda Common Service Manual (Part Number: 61CM000) explains the theory of operation and provides basic service information for various systems common to all Honda motorcycles, scooters, ATVs and Pilots.
- The Model Specific Service Manual (Part Number: 61MT405) contains service procedures specific only to your model.

These Honda manuals are written for the professional technician, but most mechanically-capable owners should find them easy to use if they have the proper tools and observe proper safety procedures. Special Honda tools are necessary for some procedures.

The Service Manuals used by your authorized Honda dealer are available from your dealer's parts department.

Some service procedures require reference to Honda's Common Service Manual as well as the Model Specific Service Manual. Consult your authorized dealer for details.

## **EMISSION CONTROL SYSTEMS**

### **Source of Emissions**

The combustion process produces carbon monoxide and hydrocarbons. Control of hydrocarbons is very important because under certain conditions, they react to form photochemical smog when subjected to sunlight. Carbon monoxide does not react in the same way, but it is toxic. Honda Motor Co., Ltd. utilizes lean carburetor settings and other systems to reduce carbon monoxide and hydrocarbons.

### **Exhaust Emission Control System**

The exhaust emission system consists of a secondary air supply system which introduces filtered air into the exhaust gases in the exhaust port. No adjustments to this system should be made although periodic inspection of the components is recommended. The secondary air supply system helps improve emission performance. The exhaust emission control system is separate from the crankcase emission control system.

**Evaporative Emission Control System (California only)**

This motorcycle complies with the California Air Resources Board (CARB) requirements for evaporative emission regulations. Fuel vapor from the fuel tank and carburetor is directed into the charcoal canister and air cleaner where it is adsorbed and stored while the engine is stopped. When the engine is running and the purge control diaphragm valve is open, fuel vapor in the charcoal canister and air cleaner is drawn into the engine through the carburetor.

**Crankcase Emission Control System**

The engine is equipped with a closed crankcase system to prevent discharging crankcase emissions into the atmosphere. Blow-by gas is returned to the combustion chamber through the air cleaner and the carburetor.

**Noise Emission Control System**

**TAMPERING WITH THE NOISE CONTROL SYSTEM IS PROHIBITED:** Federal law prohibits the following acts or the causing thereof: (1) The removal or rendering inoperative by any person, other than for purposes of maintenance, repair, or replacement, of any device or element of design incorporated into any new vehicle for the purpose of noise control prior to its sale or delivery to the ultimate purchaser or while it is in use; or (2) the use of the vehicle after such device or element of design has been removed or rendered inoperative by any person.

**AMONG THOSE ACTS PRESUMED TO CONSTITUTE TAMPERING ARE THE ACTS LISTED BELOW:**

1. Removal of, or puncturing the muffler, baffles, header pipes or any other component which conducts exhaust gases.
2. Removal of, or puncturing any part of the intake system.
3. Lack of proper maintenance.
4. Replacing any moving parts of the vehicle, or parts of the exhaust or intake system, with parts other than those specified by the manufacturer.

**Problems that May Affect Motorcycle Emissions**

If you are aware of any of the following symptoms, have the vehicle inspected and repaired by your authorized Honda Motorcycle Dealer:

1. Hard starting or stalling after starting
2. Rough idle
3. Misfiring or back firing during acceleration
4. After-burning (backfiring)
5. Poor performance (driveability) and poor fuel economy

## **WARRANTY SERVICE**

### **Owner Satisfaction**

Your satisfaction and goodwill are important to your dealer and to us. The details of all Honda warranties are explained in the Distributor's Limited Warranty. Normally, any problems with the product will be handled by your dealer's service department. Sometimes, however, in spite of the best intentions of all concerned, misunderstandings can occur. If your problem has not been handled to your satisfaction, we suggest you take the following action:

- Discuss your problem with a member of dealership management. Often complaints can be quickly resolved at that level. If the problem has already been reviewed with the Service Manager, contact the owner of the dealership or the General Manager.
  
- If your problem still has not been resolved to your satisfaction, contact the Motorcycle Customer Service department of American Honda Motor Co., Inc. The address is P.O. Box 2220, Torrance, CA90509-2220. Telephone: (310) 532-9811. We will need the following information in order to assist you:
  - Your name, address and telephone number
  - Product model and serial number
  - Date of purchase
  - Dealer name and address
  - Nature of the problem

After reviewing all the facts involved, you will be advised of what action can be taken.

Please bear in mind that your problem will likely be resolved at the dealership, using the dealer's facilities, equipment, and personnel, so it is very important that your initial contact be with the dealer.

Your purchase of a Honda product is greatly appreciated by both the dealer and American Honda Motor Co., Inc. We want to assist you in every way possible to assure your complete satisfaction with your purchase.



**REPORTING SAFETY DEFECTS**

If you believe that your vehicle has a defect which could cause a crash or could cause injury or death, you should immediately inform the National Highway Traffic Safety Administration (NHTSA) in addition to notifying American Honda Motor Co., Inc.

If NHTSA receives similar complaints, it may open an investigation, and if it finds that a safety defect exists in a group of vehicles, it may order a recall and remedy campaign. However, NHTSA cannot become involved in individual problems between you, your dealer, or American Honda Motor Co., Inc.

To contact NHTSA, you may either call the Auto Safety Hot line toll-free at 1-800-424-9393 (or 366-0123 in Washington, D.C. area) or write to: NHTSA, U.S. Department of Transportation, Washington, D.C. 20590. You can also obtain other information about motor vehicle safety from the Hot line.

**HONDA MOTOR CO., LTD.**

31MZ7610  
00X31-MZ7-6101

© Y © 20009407S  
PRINTED IN JAPAN